



FP-25 Flow Calibrator for Particulate Air Samplers & FP-25BT with Bluetooth



Operating Manual

Thank you for purchasing an Alicat FP-25 or FP-25BT.

You are about to use the most advanced instrument available for calibrating particulate air sampler flow rates. We know you are going to love your new FP-25. If you have any questions about operating it, or if something is not working as you had expected, please let us know. We are eager to help you in every way we can.

Alicat Scientific, Inc.
info@alicat.com • alicat.com
7641 N Business Park Drive Tucson, AZ 85743 USA
1-520-290-6060

Serial Number: _____

Next Calibration: _____

Recalibrate your FP-25 every year, in just 10 days.

Your calibration date is labeled on the back of the FP-25. Write that date in the space above. We complete most calibrations within 10 business days of receiving your device. When it's time for your FP-25's annual recalibration, contact us by phone, email or live chat to set it up. Or, fill out the Service Request Form at alicat.com/service.

 All Alicat devices come with a NIST traceable calibration certificate.

 The Alicat FP-25 conforms to the European Union's Restriction of Use of Hazardous Substances in Electrical and Electronic Equipment (RoHS) Directive 2011/65/EU.

 The Alicat FP-25 complies with the requirements of the Low Voltage Directive 2014/35/EU and the EMC Directive 2014/30/EU and carries the CE Marking accordingly.

 The Alicat FP-25 complies with the requirements of the European Union's Waste Electrical & Electronic Equipment (WEEE) Directive 2002/96/EC.

9/12/2017 Rev.1 DOC-FP25MAN

Welcome to the Alicat way.

You're busy, and the last thing you want to do is waste time wrestling with your flow calibrator. We're here to make your life a little easier so you can do what you do best. It's our pleasure to introduce you to your new FP-25:

- **Detailed default SOPs** give you an easy starting point to incorporate FP-25 SOPs into your air monitoring agency's guidelines, [page 50](#).
- **Calibrate any low-volume sampler, period.** Laminar flow technology makes your FP-25 just as accurate at 1 lpm as it is at 25 lpm, [page 20](#).
- **Direct Mode** puts the FP-25 in the middle of the action, literally. Monitor the flow conditions under the PM₁₀ inlet without interference, [page 16](#).
- **Climb ladders less.** Run BAM and TEOM flow calibrations from the comfort of your shelter via Bluetooth communications (FP-25BT only), [page 45](#).
- **1000 readings per second** reveal oscillating flow rates. Take timed measurements to smooth these out, [page 27](#).
- **Use it in any weather, from Anchorage to Miami.** We've tested your FP-25 from -30°C to +60°C, and we have the sunburns to prove it.
- **External temperature probe** responds to ambient temperature changes faster so your actual volumetric flow readings are always accurate, [page 13](#).
- **Any humidity, at any temperature.** Your FP-25 is the first flow calibrator built with live RH sensing, keeping it accurate in high humidity, [page 20](#).
- **Backlit display with adjustable contrast** is easy to read in direct sunlight. Up at the crack of dawn? Press the Alicat logo to turn on the backlight.
- **Monitor pressure during sampler leak checks.** Internal pressure sensors let you validate leak check results or troubleshoot problems, [page 56](#).
- **Change your STP** to match any standard temperature and pressure reference, or easily convert data to IMPROVE network references, [page 35](#).
- **Accidents happen, like your flow calibrator falling off the roof.** We've designed your FP-25 to survive drops, and likely still be in calibration.
- **Sing in the rain.** IP67 weatherproof connectors protect your FP-25 if it starts to rain during your calibration.
- **Charge it anywhere.** A full charge powers your FP-25 for up to 12 hours. To recharge, plug the micro-USB cable into any PC or power supply, [page 12](#).
- **Log data to your PC.** Talk to the FP-25 serially using the USB connector to capture all flow data for logging and analysis, [page 38](#).
- **Pack it your way.** Keep everything connected, or take it all apart. The FP-25 hard case lets you store the device any way you want, [page 9](#).
- **Nerdy? We are, too.** Read all about the FP-25's theory of operation, including humidity, temperature, pressure and flow readings, [page 20](#).

Table of Contents

Quick-Start Guide	6
Setup	6
Operation: Flow Verification	7
Operation: Leak Check Pressure Verification	7
Maintenance and Care	7
Getting Started	8
Unboxing Your FP-25 or FP-25BT	8
Storing Your FP-25	9
Getting to Know Your FP-25	10
<i>Connectors and Fittings</i>	10
<i>The FP-25 Display</i>	11
<i>Error Codes</i>	11
Charging Your FP-25	12
Connecting the External Temperature Probe to Your FP-25	13
Connecting Your FP-25 to an Air Sampler	14
<i>Standard Mode connections to air samplers via the barb fitting</i>	15
<i>Direct Mode connections to air samplers with 1.25" downtubes</i>	16
<i>Direct Mode connections for leak checks</i>	17
Understanding How the FP-25 Works	18
Overview and Function in EPA Reporting	18
Theory of Operation	20
<i>Gas Viscosity and Relative Humidity</i>	20
<i>Probe vs Stream Temperature Readings</i>	21
<i>Ambient vs Internal Pressure Readings</i>	22
<i>Actual vs Standardized Flow Readings</i>	23
Navigating and Customizing Your FP-25	25
FP-25 Menu Map	25
Collecting Data in Standard Mode	26
<i>Instant Data in Standard Mode</i>	26
<i>Averaged Data in Standard Mode</i>	27
Choosing Engineering Units from Standard Mode	29
Collecting Data in Basic Mode or Direct Mode	30
Menu	31
<i>Taring Your FP-25</i>	31
Reviewing Averaged Measurements	32

About	33
Basic Configuration Menu	34
<i>Choosing Device Engineering Units from the Basic Configuration Menu</i>	34
<i>Defining STP/NTP Reference Values</i>	35
Advanced Setup	36
Sensor Setup	37
Setting up the Real-Time Clock	38
Setting Up Serial or Bluetooth Communications	38
Configuring the FP-25 for Serial Communications	39
Serial Communications	40
Setting Up Serial Communications	40
Setting Time and Date Serially	40
Serial Streaming vs Polling	41
Collecting Live Flow Data Serially	42
Taking Averaged Measurements Serially	43
Quick Serial Command Guide	44
Bluetooth Communications (FP-25BT Only)	45
Setting Up Bluetooth Communications	45
Using Alicat Connect™ with Your FP-25BT	47
<i>Connecting Alicat Connect to Your FP-25BT</i>	47
<i>Monitoring Instant Data with Alicat Connect</i>	49
<i>Collecting Averaged Data with Alicat Connect</i>	49
Standard Operating Procedures (SOPs)	50
Verifying Ambient Air Temperature	51
Verifying Filter Temperature	53
Verifying Ambient Pressure	55
Verifying Internal Pressure during Leak Checks	56
Verifying Flow Rates in Direct Mode	59
Verifying Flow Rates in Standard Mode	63
Alicat FP-25 Field Performance Check Sheet	67
Troubleshooting Your FP-25	68
Maintenance and Recalibration	75
Specifications	76
Mechanical Drawings	77
FP-25 Graphical Quick-Start	80

Quick-Start Guide

(See diagrams on back cover.)

The Alicat FP-25 is a NIST-traceable flow, pressure and temperature calibration standard. It provides accurate readings of both actual volumetric flow and standardized (mass) flow from 25 lpm/slpm down to 0.1 lpm/slpm. Your FP-25 is weatherproof and is designed to remain accurate in air temperatures from -30°C (-22°F) to +60°C (+140°F) and at any humidity level, 0-100% RH.

Setup

We've fully charged your FP-25 at the factory, so you can use it right away.

- **Tare your FP-25.** Before you connect the calibrator to an air sampler, ensure that no air is flowing through the device and select **MENU > TARE**.



Note: The FP-25 is sensitive enough to measure the lightest of breezes, so ensure that one end is plugged before selecting tare.

- **Choose your engineering units.** In Standard Mode, you can touch the button above or below any parameter to enlarge it in the middle of the display. If you touch that same item a second time, you can change the engineering unit for that parameter. You can select units for all of the parameters at once by selecting **MENU > SETUP > BASIC CONFIG > DEVICE UNITS**.
- **Set up your averaging timer.** Select **MENU > SETUP > BASIC CONFIG > AVG TIME** to set the duration of averaged measurements, from 1 sec to as long as almost 10 hours. The FP-25 will add 1000 measurements to the average for each second.
- **Connect the external temperature probe to the FP-25.** When possible, we recommend using the external temp probe when capturing flow readings. Whenever the FP-25 is using the probe to provide readings, the word **Probe** will flash on the right side of the display. When the temperature sensor that is in the flow stream is used, **Stream** will flash on the right side of the display.
- **Connect the FP-25 to your air sampler.** Each of the FP-25 fittings has an embedded face seal, so there is no need to apply Teflon tape to the threads.
 - » If you are using a sampler that has a standard 1.25" diameter downtube, or an adapter for this size, we recommend using the Direct Mode fittings. Rotate the FP-25 display by selecting **MENU > BASIC MODE > ROTATE**. Connect the larger downtube adapter to the right (outlet) side of the FP-25, and the smaller PM inlet adapter to the left (inlet) side. Connect the FP-25 to the top of the sampler downtube, or the PM_{2.5} cyclone if you are using one. Then replace the PM₁₀ inlet on top of the FP-25.
 - » For all other samplers, connect the included barb fitting to the right (outlet) side of the FP-25. Attach the included length of silicone tubing to the barb fitting on the FP-25 and the barb on your sampler.

Quick-Start Guide

Operation: Flow Verification

- **Monitor live flow readings.** In both Standard Mode and Basic Mode, you can monitor live readings of flow, pressure and temperature by viewing the **Instant** screen. Readings are updated in real time.
- **Capture an averaged reading.** Select **START AVG** in either mode to begin a timed average. The averages update in real-time until the measurement time is complete. In Standard Mode, you can highlight any parameter in the middle of the screen, just as you did on the **Instant** screen.
- **Tare your FP-25 before calibrating the next sampler.** For best results, get a fresh tare when you move the FP-25 to a new sampler. Select **MENU > TARE**.

Operation: Leak Check Pressure Verification

You can monitor the sub-atmospheric pressures inside an air sampler during a leak check using the FP-25's flow stream pressure sensors.

- **Rotate the FP-25 display.** Select **MENU > BASIC MODE > ROTATE**.
- **Mount the FP-25 beneath the leak check adapter.** If you are already in Direct Mode, simply replace the PM₁₀ inlet with the leak check adapter.
- **Monitor live pressure readings.** Line pressure readings are presented in both absolute (e.g., PSIA) and gauge (e.g., PSIG) pressure units. Readings are updated in real time when viewing the **Instant** screen.

Maintenance and Care

- All connections and seals satisfy IP67 requirements for ingress protection, so your FP-25 will not be damaged if it rains unexpectedly.
- We have designed the FP-25 to withstand drops onto concrete from shed rooftops. If dropped, your FP-25 will likely retain its calibration, but the best practice is to verify correct flow readings against a known-good FP-25.
- **Calibrate your FP-25 annually.** Request an Alicat factory calibration at alicat.com/service or by calling Alicat at 1-888-290-6060.

Getting Started

Unboxing Your FP-25 or FP-25BT

Your FP-25 was shipped to you in its custom hard case, containing the items in the packing list below. Please contact Alicat immediately if you find that any item is missing from your FP-25 shipping box.

Receiving Inspection

- FP-25 battery-powered flow calibrator for particulate matter samplers (with flow body caps and connector plugs)
- External temperature probe with 6 feet of cable and M8 connector
- Bluetooth antenna with threaded SMA connector (FP-25BT only)
- ¼" NPT Direct Mode PM inlet adapter (1.25" OD) with face seal
- ¼" NPT Direct Mode downtube adapter (1.25" ID) with face seal
- ¼" NPT barb fitting for ¼" hoses
- 5-foot length of ¼" ID x 7/16" OD silicone tubing
- USB cable, micro-B to type A, for communications and charging
- Universal 2.0A 100-240 VAC to 5 Vdc wall adapter with USB type A connector and international plug shapes
- NIST-traceable calibration certificate
- User manual with sample SOPs for commonly-used particulate samplers
- Waterproof hard case with custom foam insert

✓ **Note: The FP-25 case also accommodates (but does not include) additional user-supplied items, such as flow audit/leak check adapters.**



Getting Started

Storing Your FP-25

We shipped your FP-25 to you with all fittings unconnected, but the FP-25 case allows you to keep as much or as little of it connected as you like.

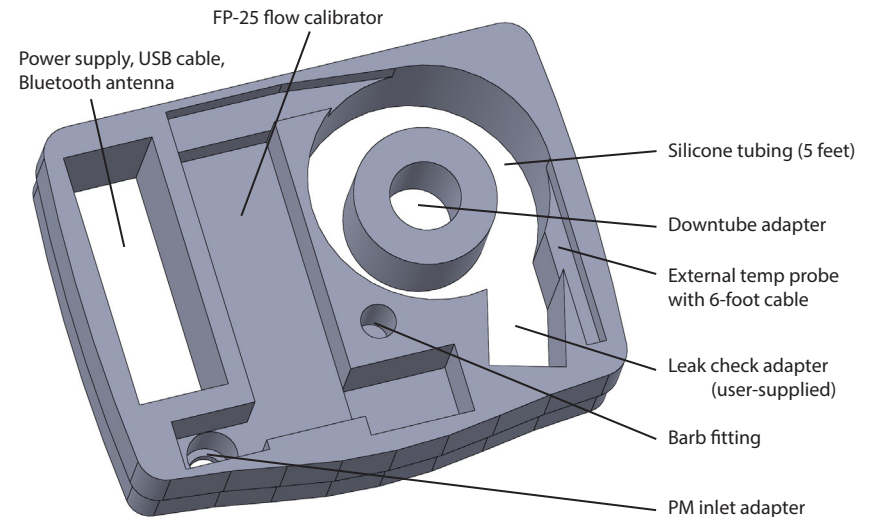

FP-25 and accessories in hard case, shown in their original unconnected arrangement when packed at the factory.



FP-25 in hard case, shown packed in its Direct Mode configuration with temp probe connected. The user-supplied inlet adapter may remain connected to the silicone tubing when stored.

Getting Started

Getting to Know Your FP-25

The Alicat FP-25 is a NIST-traceable flow, pressure and temperature calibration standard for particulate matter air samplers used in ambient air monitoring. It provides accurate readings of both actual volumetric flow and standardized (mass) flow from 25 lpm/slpm down to 0.1 lpm/slpm. Your FP-25 is weatherproof and is designed to remain accurate in air temperatures from -30°C (-22°F) to +60°C (+140°F) and at any humidity level, 0-100% RH.

Connectors and Fittings

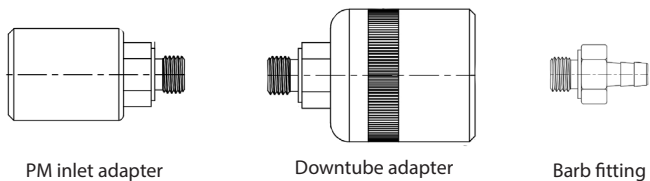
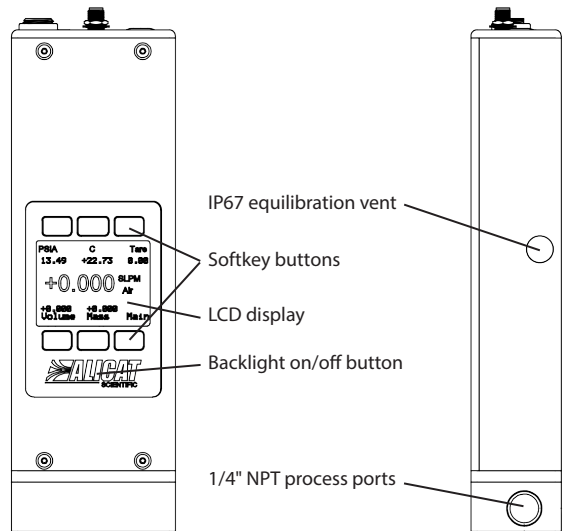
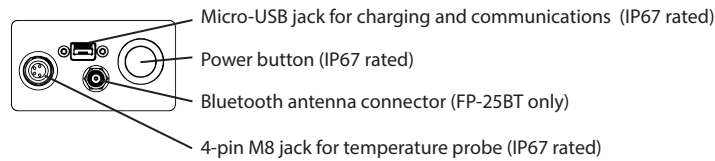

Direct Mode Adapters

Getting Started

The FP-25 Display

The figure below identifies the various features of the FP-25 display when it is in Standard Mode (upright orientation) and displaying live flow data. Press the large button with the Alicat logo to toggle the backlight on and off.

For more details, see the Menu Map on page 25 and the menu-by-menu descriptions that follow it.

Standard Mode | Instant Data

Highlights pressure in the center. Push a second time to choose pressure parameter:
 Internal absolute pressure: **+13.50** ^{psiA} RH 38%
 Abs Press

Highlights temperature in the center:
+24.38 °C RH 38%
 Temp

START AVG Begins an averaged measurement (page 27).
 Engineering unit for the highlighted parameter.
 Alternating display of:
 • Relative humidity (RH%)
 • Temperature source:
 LPM Probe = external temperature probe
 LPM Stream = internal temperature sensor

Internal gauge pressure:
-0.12 ^{psiG} RH 38%
 Gage Press

Barometric pressure:
+704.0 ^{mmHgA} RH 38%
 Baro Press

Highlights volumetric (actual) flow rate in the center:
+16.667 LPM RH 38%
 Vol Flow

Highlights standard (mass) flow rate in the center:
+15.442 SLPM RH 38%
 Std Flow

MENU Enters the menu system (page 31).
 Alternating display of:
 • Battery level indicator and charging status (page 12)
 • Error messages (see below)

Error Codes

- | | |
|---------------------------------------|------------|
| Analog-digital converter error: | ADC |
| Pressure over range of device: | POV |
| Temperature over range of device: | TOV |
| Volumetric flow over range of device: | VOV |
| Mass flow over range of device: | MOV |
| Totalizer missed out of range flow: | TMF |
| Front display is locked: | LCK |

Getting Started

Charging Your FP-25

We've fully charged your FP-25 at the factory, so you can use it right away. Expected battery life of a fully-charged battery is 12 hours of continuous operation when the backlight is off, or 8 hours when the backlight is on.

The battery indicator on the right side of the Main screen in Standard Mode reflects the relative battery level. When the battery indicator is completely empty, only about 15 minutes of battery life remains. Please charge the FP-25 as soon as possible to maintain full device performance.

Charge the FP-25 using the supplied USB cable (micro-B to type A) or any similar cable. You may charge the FP-25 using any USB outlet on a computer or portable power supply, but charging will be fastest (approximately 3.5 hours) when connected to the supplied 2.0A power supply.

Your FP-25 may be used while it is charging. A small lightning bolt symbol (⚡) will appear to the right of the battery symbol while the device is charging. If the battery has been fully depleted, you may need to charge the FP-25 for a full minute before the device can be turned on.

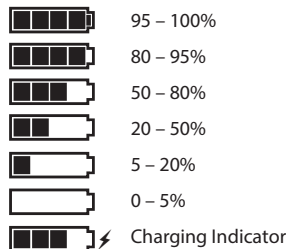
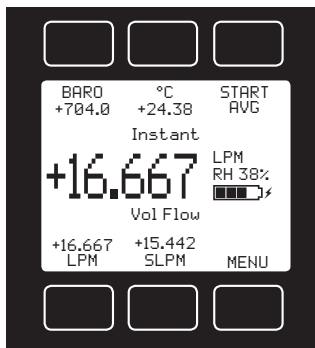

- ⚠ **Warning:** If the device is left on until the battery can no longer power it, the charge indicator will fall out of sync with the actual charge. The device can be re-synced by fully charging the battery once.
- ⚠ **Warning:** The safe charging temperature range is 0° to +45°C. If internal sensors detect temperatures outside of this range, the battery will not charge.

Getting Started

Connecting the External Temperature Probe to Your FP-25

We recommend using the external temperature probe when capturing flow readings. Whenever the FP-25 is using the probe to provide readings, the word **Probe** will flash on the right side of the display. When the temperature sensor that is in the flow stream is used, **Stream** will flash on the right side of the display. See "Probe vs Stream Temperature Readings" on page 21 for details.

Connect the external temperature probe to the FP-25 by aligning its 4-pin M8 connector with the 4-pin M8 receptacle on top of the FP-25. When properly aligned, the cable of the temperature probe will pass over the power button. Push the connector in all the way, and then tighten the locking collar on the connector to secure it.

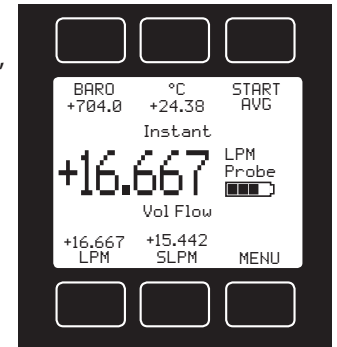

- ✓ **Note:** The M8 connector on the FP-25BT is angled so the temperature probe cable can pass in front of the Bluetooth antenna when it is connected. This also allows the FP-25BT to be stored in its case with both the temperature probe and Bluetooth antenna still connected.



Connecting Your FP-25 to an Air Sampler

Your FP-25 has 0.25" female NPT ports on each end of its flow body and comes with three adapters for ease in connecting it to your air samplers. Each of the supplied fittings has an embedded face seal, so there is no need to apply Teflon tape to the threads.



- **Caution:** Do not use pipe dopes or sealants on the process connections. These compounds can cause permanent damage to the FP-25 should they get into the flow stream.

You can mount or hold the FP-25 in any position, because it is internally compensated for any changes to its orientation during use. This makes possible Alicat's exclusive Direct Mode connection for pass-through calibration of FRM and FEM samplers. When mounting the FP-25 in Direct Mode, you can rotate the FP-25 display by selecting **MENU > BASIC MODE > ROTATE**. The FP-25 is also unaffected by vibrations, so you can rest the base of the FP-25 on top of even a badly vibrating sampler without sacrificing measurement accuracy.

Standard Mode connections to air samplers via the barb fitting

The Standard Mode of your FP-25 shows live flow readings that are oriented in the same direction as the logo on the front of the device. In this mode, you can use the supplied barb adapter and silicone tubing to connect to any air sampler, big or small. When using the FP-25 in Standard Mode, you can rest its base on top of the sampler or hold it in your hand.

1. Thread the supplied barb fitting into the right (outlet) side of the FP-25. Then fit one end of the supplied silicone tubing over the barb.
2. Attach the other end of the tubing according to your sampler type:

- **FRM or FEM sampler with a standard**

- 1.25" downtube:** Remove the PM₁₀ inlet from the downtube. Then attach the sampler's flow audit adapter (also called a leak check adapter) to the top of the downtube (or PM_{2.5} cyclone, if used). Fit the other end of the tubing onto the end of the flow audit adapter's barb fitting.

- **Sampler with a larger downtube**

- (IMPROVE or URG-3000):** Remove the sampling inlet from the downtube. Then attach the sampler's 1.25" downtube adapter and the standard 1.25" flow audit adapter (also called a leak check adapter) to the top of the downtube. Fit the other end of the tubing onto the end of the flow audit adapter's barb fitting.

- **SASS or SuperSASS:** Fit the other end of the tubing into the individual filter's sampling inlet port. The outside diameter of the supplied silicone tubing is just the right size to create a seal against the inside surface of the inlet port.

- **Sampler with a low flow rate (1-5 lpm):** You may need to adapt the smaller inlet diameter of the downtube to accommodate a minimum 0.25" standard barb fitting. Remove any screen that surrounds the inlet, and then connect the inlet adapter to the other end of the supplied silicone tubing.



Direct Mode connections to air samplers with 1.25" downtubes

If you are using a sampler that has a standard 1.25" diameter downtube, or a sampler that includes an adapter for this standard downtube size, we recommend using Direct Mode, because it most closely reflects the flow conditions during normal sampler operation.

1. Prepare the FP-25 for Direct Mode by selecting **MENU > BASIC MODE** and then selecting **ROTATE** to rotate the screen.
2. Mount the FP-25 beneath the PM₁₀ inlet.

- 2.1 If the FP-25 is not already connected in Direct Mode, remove the PM₁₀ inlet from the downtube.
 - » Connect the larger downtube adapter to the right (outlet) side of the FP-25, and the smaller PM inlet adapter to the left (inlet) side.
 - » Mount the FP-25 to the top of the sampler downtube, or to the PM_{2.5} cyclone if you are using one. The downtube adapter of the FP-25 should fit snugly over the downtube.
 - » Place the PM₁₀ inlet on top of the FP-25, sliding it over the end of the FP-25's PM inlet adapter.

- 2.2 If you are already in Direct Mode, replace the leak check adapter with the PM₁₀ inlet, sliding it over the end of the FP-25 PM inlet adapter.



Caution: The FP-25 is optimized for use at near-atmospheric pressures. Using this device under positive pressure is not recommended. Using the FP-25 above 45 psig of internal line pressure, or 15 psi of differential pressure between the inlet and outlet, will result in permanent damage to the internal pressure sensors.

Direct Mode connections for leak checks

If you are using a sampler that has a standard 1.25" diameter downtube, or a sampler that includes an adapter for this standard downtube size, you may also use Direct Mode to monitor the sub-atmospheric pressures inside the air sampler when conducting leak checks.

1. Prepare the FP-25 for Direct Mode by selecting **MENU > BASIC MODE** and then selecting **ROTATE** to rotate the screen.

2. Mount the FP-25 beneath the leak check adapter.

2.1 If the FP-25 is not already connected in Direct Mode, remove the PM₁₀ inlet from the downtube.

- » Connect the larger downtube adapter to the right (outlet) side of the FP-25, and the smaller PM inlet adapter to the left (inlet) side.
- » Mount the FP-25 to the top of the sampler downtube or PM_{2.5} cyclone, if used. The downtube adapter of the FP-25 should fit snugly over the downtube.

- » Place the leak check adapter (flow audit adapter) on top of the FP-25, sliding it over the end of the FP-25's PM inlet adapter.

2.2 If you are already in Direct Mode, replace the PM₁₀ inlet with the leak check adapter, sliding it over the end of the FP-25 PM inlet adapter.

✔ **Note:** During leak checks in Direct Mode, the FP-25 will provide flow readings in addition to pressure readings, but these are not comparable to any flow readings reported by the sampler, other than confirming a no-flow condition. Whereas the sampler is measuring flow at the end of the flow path, the FP-25's location right after the closed valve on the leak check adapter prevents it from providing meaningful flow measurements during leak checks.



Understanding How the FP-25 Works

Overview and Function in EPA Reporting

The Alicat FP-25 is a NIST-traceable flow, pressure and temperature calibration standard for particulate matter air samplers used in ambient air monitoring. Particulate samplers used in US Environmental Protection Agency (EPA) reporting must maintain consistent flow rates in order to keep their reports of atmospheric particulate matter concentrations standardized and accurate.

The US Code of Federal Regulations (CFR), Title 40, Part 50 defines the national standards for ambient air quality and their measurement methods. The Alicat FP-25 flow, pressure and temperature calibrator has been designed to exceed all EPA requirements for calibration of both PM₁₀ and PM_{2.5} federal reference method (FRM) ambient air samplers and their equivalents (FEM).

40 CFR Part 50, Appendix J for PM₁₀ air sampling

40 CFR Part 50, Appendix J (Reference Method for the Determination of Particulate Matter as PM₁₀ in the Atmosphere) defines PM₁₀ flow rate calibration and verification procedures.

Paragraph 8.2.2 requires that the flow rate standard be NIST-traceably calibrated such that its reported actual flow rate (volumetric flow) be accurate to within 2% of reading over the expected operational range of ambient temperatures and pressures.

40 CFR Part 50, Appendix L for PM_{2.5} air sampling

40 CFR Part 50, Appendix L (Reference Method for the Determination of Fine Particulate Matter as PM_{2.5} in the Atmosphere) defines the PM_{2.5} flow rate calibration and verification procedures.

Paragraph 9.2.2 requires that the flow rate standard be NIST-traceably calibrated such that its reported actual flow rate (volumetric flow) be accurate to within 2% of reading over the expected operational range of ambient temperatures and pressures.

Paragraph 7.4.7 defines the air sampler' range of operational conditions as -30°C to +45°C, 0-100% RH and 600-800 mmHg. ***We have designed and tested the FP-25 to achieve 1% of reading flow accuracy across all possible combinations of these operating conditions.***

Understanding How the FP-25 Works

EPA Quality Assurance Handbook, Vol. II

The EPA's Quality Assurance Handbook, Volume II (Ambient Air Quality Monitoring Program), Section 12.1.3 (Table 12-1), requires that the standards used for calibration of the air sampler's sensors be accurate to within 2% of the NIST-traceable standard for flow rate, 1 mmHg for barometric pressure and 0.5°C for temperature. These requirements and the corresponding FP-25 performance specifications are summarized below:

Criteria	EPA Acceptable Range	FP-25 Specification
Flow rate	±2% of NIST-traceable standard	±1% of reading of NIST-traceable standard
Pressure	±1 mmHg resolution ±1 mmHg accuracy	±0.1 mmHg resolution ±1 mmHg accuracy
Temperature	±0.1°C resolution ±0.5°C accuracy	±0.01°C resolution ±0.2°C accuracy

In addition to the above EPA-defined performance criteria, the FP-25 has been designed to maintain 1% of reading flow accuracy across the entire operating range of ambient particulate matter air samplers, defined as -30°C (-22°F) to +45°C (+113°F), 0-100% RH and 600-800 mmHg.

Including the FRM and FEM air samplers noted previously, the FP-25 can be used with the following types of air samplers and their associated flow ranges:

- » FRM and FEM air samplers nominally operating at 16.7 lpm
- » FEM air samplers nominally operating at 16.7 lpm with split flows at 1.0/15.7 lpm, 1.7/15.0 lpm, 2.0/14.7 lpm, 3.0/13.7 lpm or 1.7/3.0/12.0 lpm
- » Carbon speciation samplers nominally operating at 22 or 6.7 lpm
- » IMPROVE network PM samplers nominally operating at 22.8 lpm
- » PM or black carbon analyzers nominally operating at 1-5 lpm

The FP-25 provides accurate readings of both actual volumetric flow and standardized (mass) flow from 25 lpm/slpm down to 0.1 lpm/slpm.

 **Note: The FP-25 ships with a default STP (standard temperature and pressure) of 25°C and 1 atm for standardized (mass) flow readings, which matches the US EPA's standard. This STP reference can be changed to correct to the IMPROVE network mean temperature (15°C) or to overseas NTP (normal temperature and pressure, typically 0°C and 1 atm). To make this change, select MENU > SETUP > BASIC CONFIG > STP/NTP. See page 35 of this manual for details.**

Understanding How the FP-25 Works

Theory of Operation

Flow is generated by pressure differentials. At its heart, the FP-25 measures flow by monitoring those differential pressures across an internal restriction, similar to a Venturi flow meter. What sets the FP-25 apart is that the restriction is a laminar flow element (LFE), which forces all of the airflow into a laminar (non-turbulent) flow regime. This property transforms the Venturi's quadratic relationship between flow and differential pressure (pressure drop across the LFE) into a linear one. This linearity gives the FP-25 great accuracy across a much wider flow range than is achievable in a Venturi flow meter.

The mathematical equation that reflects this linear relationship is the Hagen-Poiseuille equation:

$$Q = \frac{K \Delta P}{\eta}$$

Where: Q = actual volumetric flow rate

K = a constant based on the restriction's internal geometry

ΔP = differential pressure across the LFE

η = absolute viscosity of air

Gas Viscosity and Relative Humidity

The equation above demonstrates the important role that gas viscosity plays in determining flow rates through the FP-25. Because the actual viscosity of a gas varies with changes in temperature (and pressure to a small degree), the FP-25 continuously updates the viscosity value with live readings of flow stream temperature and pressure.

The presence of water vapor in the air also has a significant impact on the air's viscosity, and this affects the accuracy of flow measurement through LFEs and Venturis both. Your FP-25 is the first flow meter to incorporate a live relative humidity sensor within the flow path. The FP-25 uses this humidity data to continuously update the viscosity value to provide accurate flow readings all the way to 100% RH, at temperatures as high as 60°C.

Understanding How the FP-25 Works | Theory of Operation

Probe vs Stream Temperature Readings

The FP-25 uses two fast-responding temperature sensors, one located at the tip of the external temperature probe and one mounted directly in the flow stream. When possible, we recommend using the external temperature probe when capturing actual volumetric flow readings. *See "Connecting the External Temperature Probe to Your FP-25" on page 13 for details.*

Whenever the FP-25 is using the external temp probe to provide readings, the word **Probe** will flash on the right side of the display, alternating with the relative humidity value. When capturing ambient temperature or actual volumetric flow readings, be sure to insert the temp probe into the air sampler's radiation shield, locating the probe's tip as close as possible to the sensor inside the radiation shield. If the sampler has no radiation shield, place the FP-25 probe in the shade in the immediate vicinity of the sampler. If the probe has previously been sitting in direct sunlight, allow a couple minutes for the temperature reading to settle at the shade temperature.

The external probe's temperature sensor is thermally isolated from the rest of the metal shaft that leads to the handle of the probe. However, like any other probe, prolonged exposure to direct sunlight will artificially elevate the temperature readings. The FP-25 temp probe equilibrates rapidly when it is moved from direct sunlight into the shade. For greatest speed of response and accuracy, do not attempt to further insulate the probe's metal shaft.

! *Caution: Some samplers have metal radiation shields. Take care not to let the tip of the FP-25 temp probe rest against this metal.*

Whenever the FP-25 is using the internal flow stream temperature sensor to provide readings, the word **Stream** will flash on the right side of the display, alternating with the relative humidity value. While just as accurate as the external temperature probe, the internal temperature sensor may provide temperature readings that are somewhat higher than those generated by the external probe. This is because the internal sensor is sensing elevations in air temperature that result from environmental heating of the flow body, including the effects of direct sunlight or holding the flow body by hand.

The FP-25 ships with temperature readings displayed in degrees Centigrade (°C). *See "Choosing Engineering Units from Standard Mode" on page 29 to change the temperature engineering units:*

Ambient vs Internal Pressure Readings

The FP-25 uses multiple pressure sensors to capture both ambient barometric pressure and internal flow stream pressure. The barometric pressure sensor monitors ambient atmospheric pressure and is housed within the instrument casing above the display. The vent located on the side of the FP-25 keeps this barometer continuously equilibrated to atmospheric pressure while retaining the instrument's IP67 protection. Whenever the FP-25 is displaying barometric pressure, **BARO** appears above the pressure value at the top left of the screen in Standard Mode. To view barometric pressure, touch the button above the pressure display in Standard Mode and select **Show baro pressure**. Barometric pressure is always referenced to absolute vacuum.

The internal flow stream pressure sensor monitors pressure inside the FP-25's flow body and is actually a suite of four pressure sensors that work in concert to generate flow and pressure readings. This sensor package monitors both differential pressure and absolute pressure within the flow stream directly. This absolute pressure sensor has a broader range (0-30 psia, or 0-1551 mmHg) than the barometric pressure sensor (375-825 mmHg). Because of this, taring the FP-25 (by selecting **MENU > TARE**) also tares the absolute pressure sensor against the current value reported by the barometer.

Whenever the FP-25 is displaying internal stream pressure, the pressure engineering unit appears above the pressure value at the top left of the screen in Standard Mode. This engineering unit is appended with the letter **A** for readings of absolute pressure or **G** for readings of gauge pressure. These readings indicate the same actual pressure, but whereas absolute pressure is referenced to absolute vacuum, gauge pressure is referenced to current barometric pressure. To view internal stream pressure, touch the button above the pressure display in Standard Mode and select **Show abs pressure** to display internal pressure with an absolute vacuum reference, or select **Show gauge pressure** to display internal pressure with an atmospheric pressure reference.

The FP-25 ships with pressure readings displayed in millimeters of mercury (mmHg). Pressure engineering units for absolute and gauge pressure always match, but barometric pressure units can be different. See "*Choosing Engineering Units from Standard Mode*" on page 29 to change the pressure engineering units:

Actual vs Standardized Flow Readings

The FP-25 uses the raw data from the multiple pressure, temperature and humidity sensors to calculate both actual (volumetric) and standardized (mass) flow readings a thousand times every second. The following are brief descriptions of each of the types of flow readings you will see on the FP-25.

- **Actual volumetric flow using the external temperature probe.** The EPA requires that flow readings for $PM_{2.5}$ be reported as actual volumetric flow readings that are referenced to ambient barometric pressure and ambient temperature. When the external temperature probe is connected, the FP-25 references the raw internal volumetric flow readings to ambient temperature using the temp probe, and to ambient pressure using the barometer. This actual volumetric flow rate reflects the actual volume of air that passes through the meter per unit of time. Whenever the FP-25 is displaying volumetric flow referenced to the temperature reading of the external probe, the word **Probe** will flash on the right side of the display, alternating with the relative humidity value. Actual volumetric flow always appears at the bottom left of the FP-25 screen in Standard Mode.

- **Actual volumetric flow using the internal temperature sensor.** When the external temperature probe is not connected, the FP-25 references the raw internal volumetric flow readings to ambient temperature using the internal temperature sensor, and to ambient pressure using the barometer. As above, this actual volumetric flow rate reflects the actual volume of air that passes through the meter per unit of time. Whenever the FP-25 is displaying volumetric flow referenced to the temperature reading of the internal temperature sensor, the word **Stream** will flash on the right side of the display, alternating with the relative humidity value.

- **Standardized (mass) flow.** Because actual volumetric flow rates change with temperature and pressure, comparisons are made easier when these actual readings are converted into standardized flow readings. The EPA requires that flow readings for PM_{10} be reported as standardized volumetric flow readings that are referenced to the EPA's standard temperature and pressure conditions (STP) of 25°C and 1 atm. Standard flow values always reference the FP-25's chosen STP, whether or not the external temperature probe is connected. For use overseas, the FP-25 will also store normal temperature and pressure (NTP) values and keep them separate from the STP values. NTP is commonly (but not always) referenced to 0°C and 1 atm.

The standardized flow rate is reported in volumetric units that reflect the equivalent volume of air that would have passed through the meter per unit of time if the defined standard temperature and pressure conditions had been met. The volumetric flow rate and standardized flow rate will equal each other

Understanding How the FP-25 Works | Theory of Operation

when the current ambient temperature and pressure equal the STP or NTP values selected on the FP-25. Standardized flow always appears at the bottom center of the FP-25 screen in Standard Mode. The displayed engineering unit will be prefixed with the letter **S** for readings of standard flow (STP) or the letter **N** for readings of normal flow (NTP).

The FP-25 ships with all flow readings displayed in liters per minute (lpm, slpm and nlpm). See "Choosing Engineering Units from Standard Mode" on page 29 to change the volumetric and standard flow engineering units:

✔ **Note: The FP-25 ships with a default STP (standard temperature and pressure) of 25°C and 1 atm for standardized (mass) flow readings, which matches the US EPA's standard. This STP reference can be changed to correct to the IMPROVE network mean temperature (15°C). To make this change, select MENU > SETUP > BASIC CONFIG > STP/NTP. To use an NTP reference (normal temperature and pressure, typically 0°C and 1 atm), simply select NLPM as your engineering unit for mass flow.**

The following table summarizes the temperature and pressure reference values used by the FP-25 when providing flow readings:

Parameter	Temperature Reference	Pressure Reference
Volumetric (actual) flow	<i>With temp probe:</i> External temp probe temperature reading	Barometric pressure reading
	<i>Without temp probe:</i> Internal temp sensor temperature reading	
Standardized (mass) flow	STP or NTP chosen temperature value	STP/NTP chosen pressure value

Navigating and Customizing Your FP-25

FP-25 Menu Map

* Pressing **MAIN** returns you to the Instant Data screen of either Standard Mode or Basic Mode, whichever was last used.

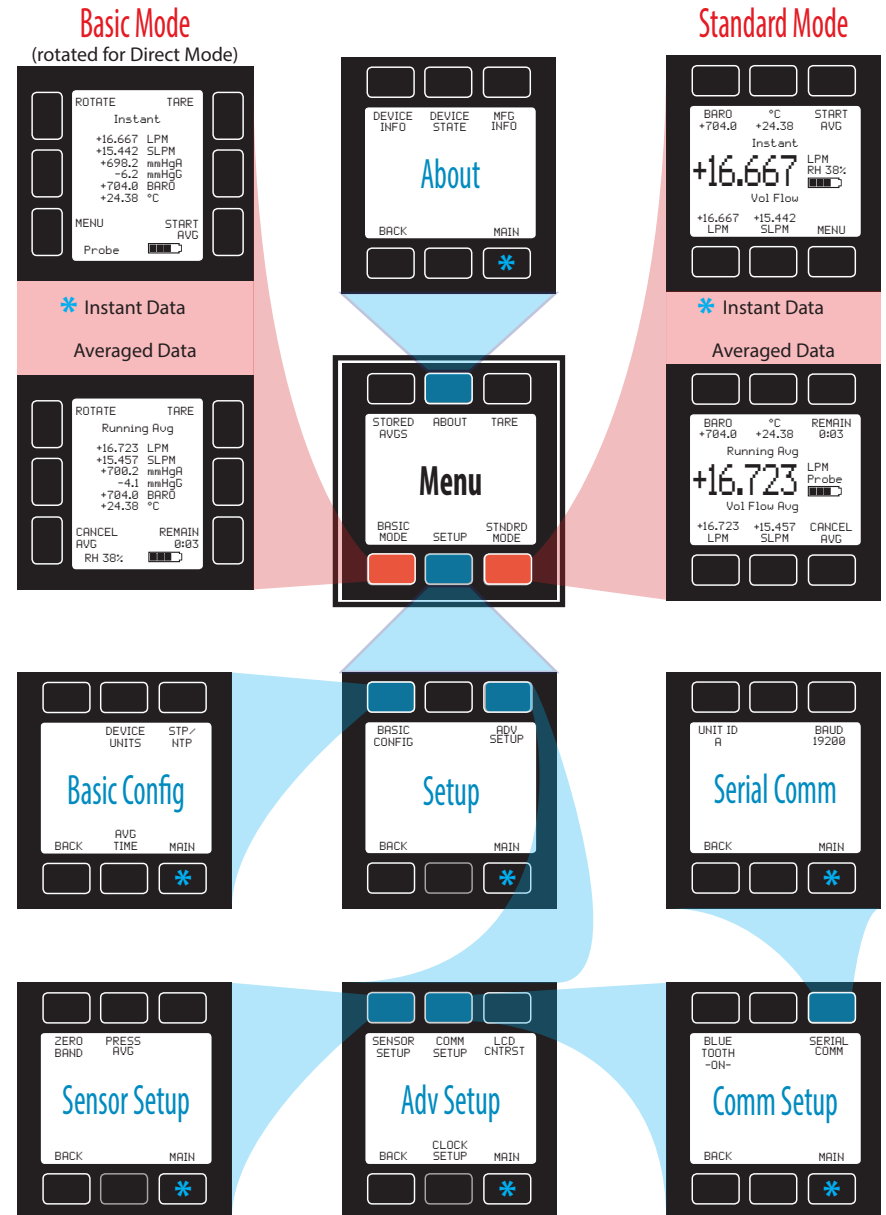

Navigating and Customizing Your FP-25

Collecting Data in Standard Mode

Standard Mode is the default data collection mode for the FP-25. You can use this mode or Basic Mode whenever you have the barb fitting and tubing connected to an air sampler. Standard Mode has three primary functions:

- Collecting instant temperature, pressure and flow data (this page, below)
- Collecting averaged temperature, pressure and flow data (page 27)
- Changing engineering units for temperature, pressure and flow (page 29)

Instant Data in Standard Mode

The **Instant** screen of Standard Mode displays live data for all flow parameters simultaneously. Live data is measured 1000 times every second and refreshed a bit slower on the display. Press the button above or below any of the four flow parameters to highlight its value in the center of the screen. Press the same button again to enter the engineering unit selection menu for that parameter (page 34).

Standard Mode | Instant Data

Highlights pressure in the center. Push a second time to choose pressure parameter:

Internal absolute pressure: **+13.50** PSIA RH 38%
Abs Press

Internal gauge pressure: **-0.12** PSIG RH 38%
Gage Press

Barometric pressure: **+704.0** mmHgA RH 38%
Baro Press

Highlights temperature in the center: **+24.38** °C RH 38%
Temp

START AVG Begins an averaged measurement (page 27).

Engineering unit for the highlighted parameter.

Alternating display of:
• Relative humidity (RH%)
• Temperature source:
LPM **Probe** = external temperature probe
LPM **Stream** = internal temperature sensor

Alternating display of:
• Battery level indicator and charging status (page 12)
• Error messages (page 11)

Highlights volumetric (actual) flow rate in the center: **+16.667** LPM RH 38%
Vol Flow

Highlights standard (mass) flow rate in the center: **+15.442** SLPM RH 38%
Std Flow

MENU Enters the menu system (page 31).

Navigating and Customizing Your FP-25

Averaged Data in Standard Mode

The averaging screen of Standard Mode displays averaged data for all flow parameters simultaneously. Flow data is measured at a rate of 1000 readings for every second of measurement time. Press the button above or below any of the four flow parameters to highlight its value in the center of the screen, even after an averaged measurement has finished. Engineering units cannot be changed from the averaging screen.

- When an average is running, the screen displays **Running Avg** at the top, and all parameter values update in real time until the average has completed. When the countdown timer stops, the screen displays **Final Avg** at the top.

✓ **Note:** If you have chosen the time remaining to be highlighted in the center of the display, this parameter will disappear once the averaged measurement is finished, just as its smaller counterpart in the top right of the display disappears and becomes **START AVG**. The time remaining parameter will reappear in the center when you start a new average.

Standard Mode | Averaged Data

Highlights pressure average in the center: **+13.50** PSIA RH 38%
Abs Press Avg

Internal gauge pressure: **-0.12** PSIG RH 38%
Gage Press Avg

Barometric pressure: **+704.0** mmHgA RH 38%
Baro Press Avg

Highlights temperature average in the center: **+24.38** °C RH 38%
Temp Avg

Highlights remaining time in the center: **0:03** h:m:s RH 38%
Time Remain

START AVG Begins another averaged measurement. Appears after a measurement has completed.

Averaging status display:
Running Avg = measuring a single average
Final Avg = completed

INST/MENU Returns to **Instant** screen. Appears after a measurement has completed.

CANCEL AVG Stops the current averaged measurement. Returns to **Instant** screen.

Navigating and Customizing Your FP-25

Instant vs Averaged Data in Standard Mode

When you are done taking averaged measurements, press **INST/MENU** to resume live readings. Press the button again to enter the menu system.

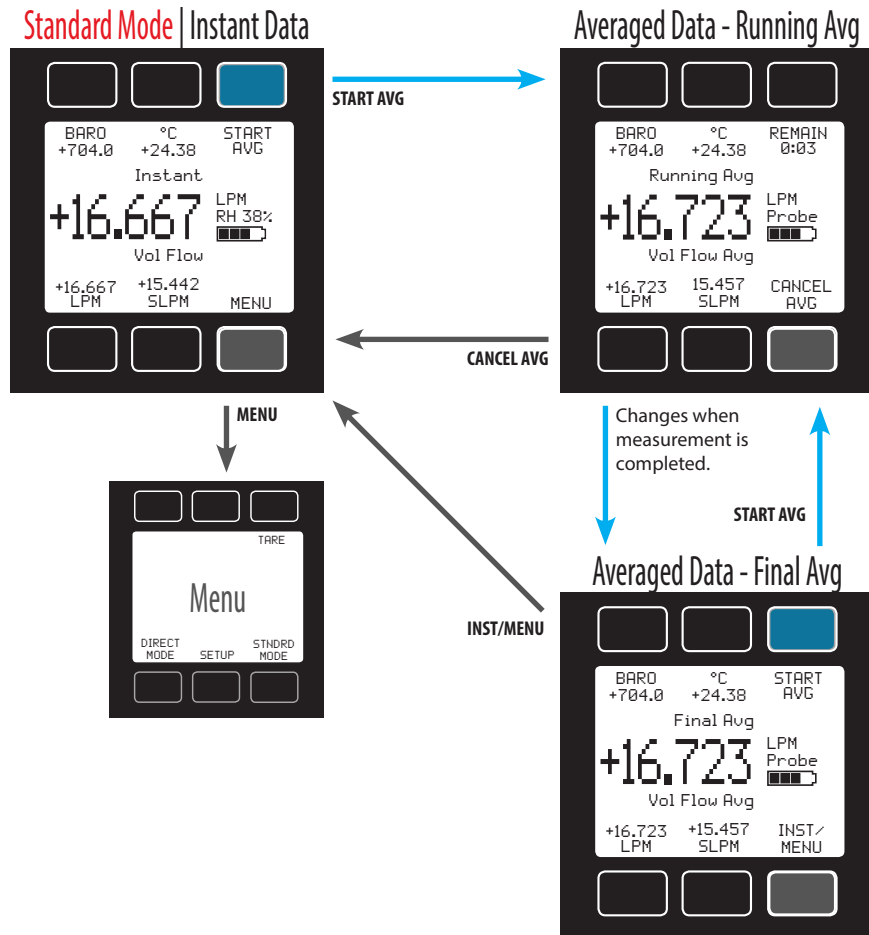

When taking an averaged measurement, a single average is taken. The resulting measurement remains on the **Final Avg** screen until you press **START AVG** or **INST/MENU**.

Navigating and Customizing Your FP-25

Choosing Engineering Units from Standard Mode

Press the button above or below any of the four flow parameters twice to enter its unit selection menu. You can change units in two ways:

Button engineering units alter the display only, not the serial data frame (see page 26):

- Select **Set button eng units** and press **SELECT** to change the engineering unit on the display only. Use the **UP** and **DOWN** keys to move the > cursor to the desired unit, and then press **SET**. This does not alter the FP-25 data frame.

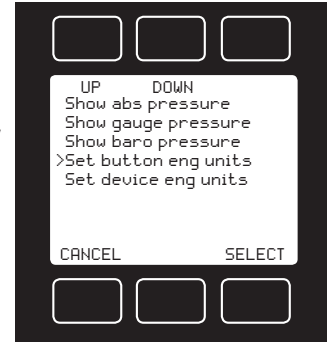

Device engineering units alter both the display and the FP-25 data frame:

- Select **Set device eng units** and then choose the engineering unit as above. An additional confirmation screen asks you to confirm the serial change.
- If the button engineering unit is different than the device engineering unit, **Set device eng units** will not appear. First select **Show device eng units** to return the button unit to the existing device unit, and then enter the unit selection menu again to change the device engineering unit.

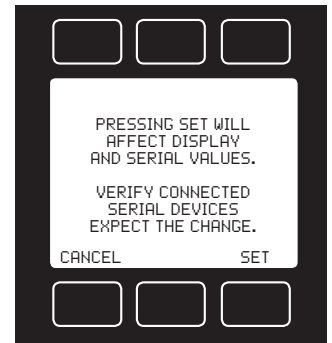

✔ **Note:** Changing button or device engineering units in the Pressure unit menu changes the units for absolute and gauge pressure readings.

Examples of changing device engineering units:

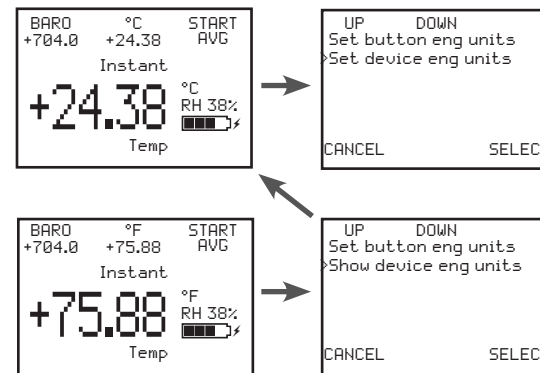

Changing device units: °C is the existing device engineering unit, so the unit selection menu displays **Set device eng units**.

Changing device units: °F is not the existing device engineering unit, so the unit selection menu displays **Show device eng units**. Enter the unit selection menu again to change the device engineering units.

Navigating and Customizing Your FP-25

Collecting Data in Basic Mode or Direct Mode

Basic Mode is a simplified view that presents the same data as Standard Mode, but in a single list. It lacks the option to highlight parameters or change engineering units, but it provides direct access to the **TARE** function. The rotated view of Basic Mode should be used whenever you are using the Direct Mode adapters to mount the FP-25 to the 1.25" downtube of an air sampler.

- » Enter Basic Mode by selecting **MENU > BASIC MODE**.
- » Select **ROTATE** to toggle the screen rotation between upright and 90°. Basic Mode remembers its rotation when you enter the FP-25's menu system.

Like Standard Mode, Basic Mode allows you to collect both instant and averaged flow data.

Basic Mode

The screenshots show the Basic Mode interface in four orientations: Instant Data (upright), Instant Data (rotated), Averaged Data (upright), and Averaged Data (rotated). Each screen displays various flow and pressure parameters. In the upright views, the 'TARE' button is at the top left, and 'START AVG' is at the top right. In the rotated views, 'ROTATE' and 'TARE' are at the top, and 'START AVG' is at the bottom right. Arrows indicate the transition between instant and averaged data screens.

Navigating and Customizing Your FP-25

Menu

You can enter the FP-25 menu system from either Standard Mode or Basic Mode by pressing the **MENU** button.

The diagram shows the menu system with callouts for the following options:

- ABOUT** Enters the About Menu (page 33).
- STOR'D AVGS** Enters the Stored Averages Log (page 32).
- TARE** Tares two parameters:
 - Gives a zero flow reference for flow measurements.
 - Aligns the internal absolute pressure sensor reading to the barometer reading.
- BASIC MODE** Enters Basic Mode (page 30).
- SETUP** Enters Setup Menu.
- STNDRD MODE** Enters Standard Mode (page 26).

Taring Your FP-25

Taring is an important practice that ensures that your FP-25 is providing the most accurate measurements possible. This function gives the FP-25 a good zero reference for flow measurements and also aligns its internal absolute pressure sensor with the barometric pressure reading (see page 22).

How to tare

1. Ensure that no air is flowing through the device. The FP-25 is sensitive enough to measure a light breeze, so be sure to plug one end, and keep the other open to atmosphere.
2. Select **MENU > TARE**.
3. At the confirmation screen, press **TARE**.

When to tare

- Before every flow check, audit or calibration.
- Before calibrating the next air sampler.
- After significant changes in temperature or atmospheric pressure.
- After dropping or bumping the FP-25.

The confirmation screen displays the text: "PRESS TARE WHEN VENTED TO AMBIENT WITH NO FLOW. Current pressure offset: +0.8 mmHgA". At the bottom, there are two buttons: "CANCEL" and "TARE".

Navigating and Customizing Your FP-25

Reviewing Averaged Measurements

Your FP-25 stores the 50 most recent timed averages in its internal Stored Averages log, with the most recent measurement at the top. When the FP-25 has stored the maximum number of measurements, each new measurement displaces the oldest measurement. You can manually delete a single measurement or all of them at once. These functions are also accessible via serial commands (see page 43).

Menu | Stored Averages

UP/DOWN Moves the selection arrow up or down the listing of log entries. **PAGE** Advances the view to the next page of log entries.

BACK Returns to the top-level Menu (page 31). **VIEW** Opens the entry for the selected measurement.

DEL ALL Permanently erases all stored measurements. Select **DELETE** at the confirmation screen.

The Stored Averages log displays three values for each stored measurement: start time (**Start**), volumetric flow and standardized mass flow. The detailed entry also displays the measurement duration (**Avg Tm**) and a unique measurement ID (**ID**).

Menu | Averaged Measurement Entry

UP AVG Views newer entry. **DN AVG** Views older entry.

DELETE Permanently erases the displayed entry.

MORE Toggles the two screens of the entry.

✔ **Note:** Log entries always reflect the current FP-25 device engineering units. If you select a new unit from the **DEVICE UNITS** menu, all existing logged measurements will be converted to your newly chosen unit.

Navigating and Customizing Your FP-25

Menu | About

DEVICE STATE Displays diagnostic information for troubleshooting (see below).

DEVICE INFO Displays serial number, firmware revision and calibration information.

MFG INFO Displays Alicat's contact information.

BACK Returns to the top-level Menu.

MAIN Returns to the Instant screen of Standard Mode or Basic Mode, whichever was last used.

About

We hope you don't run into trouble using your FP-25, but if you do, the **ABOUT** menu contains information that can make the troubleshooting process easier. Select **MFG INFO** to look up Alicat's phone number and web address. **DEVICE INFO** shows you the serial number and firmware version (**SW:**) for your specific device. It also gives you the original manufacturing date and the last calibration date, as well as the initials of the Alicat calibrator.

Diagnostic Information

The **DEVICE STATE** screen displays live register values for internal registers. Many of these values can help an Alicat applications engineer diagnose operational issues over the phone. Some register values clearly distinguish between hardware and operational problems, which speeds up the troubleshooting process.

Within the **DEVICE STATE** screen, press **PAGE** to advance to the next page of register values.

Select **RESTORE** to reset your FP-25 to factory configuration and calibration settings. Push **SET** to confirm.

DEVICE STATE screen showing register values:

Register	Value
R8: AP Sig	14810
R9: Temp Sig	39076
R10: DP Sig	9909
R11: DP Brdg	37414
R13: AP Brdg	39414
R16: MeterFunc	199
R18: Power Up	33792

Navigation options: **BACK**, **RESTORE**, **MAIN**

Navigating and Customizing Your FP-25

Basic Configuration Menu

The Basic Configuration Menu contains options for choosing the duration and time format for the averaging function, as well as device engineering units.

Setup | Basic Configuration

AVG TIME Sets the duration for averaged measurements, up to 9h:59m. Use the **SELECT DIGIT** and **UP/DOWN** buttons to choose the length of the timer countdown. Press **SET** to accept the new value. The time format is chosen in **MENU > BASIC CONFIG > DEVICE UNITS > Time**.

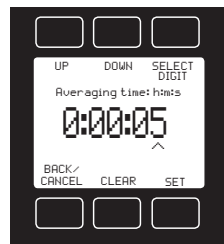

BACK Returns to the top-level Menu (page 31).

DEVICE UNITS Changes device engineering units for any parameter:
Standard Mass Flow - Volumetric Flow - Pressure - Baro Pressure - Temperature - Time

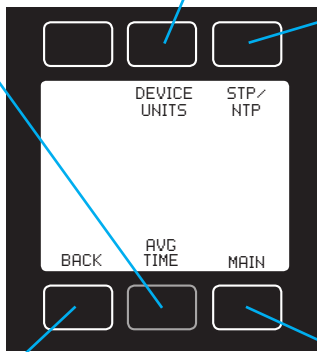

STP/NTP Defines standard (STP) and normal (NTP) temperature and pressure conditions (page 35).

MAIN Returns to the **Instant** screen of Standard Mode or Basic Mode, whichever was last used.

Choosing Device Engineering Units from the Basic Configuration Menu

Changing device engineering units alters both the display and the data frame. First choose the parameter whose unit you want to change, and then choose your desired engineering unit. Confirm the change on the last screen. Changing engineering units in the **Pressure** unit menu changes the units for both absolute and gauge pressure readings, but not barometric pressure.

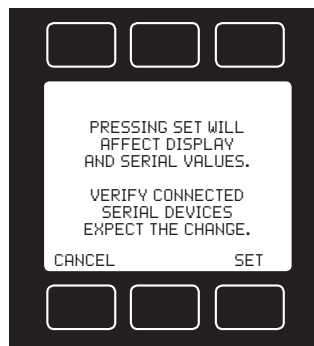
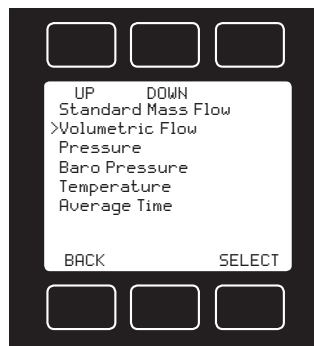

Navigating and Customizing Your FP-25

Basic Configuration | STP/NTP

Stan T: Standard Temperature
Stan P: Standard Pressure
Norm T: Normal Temperature
Norm P: Normal Pressure

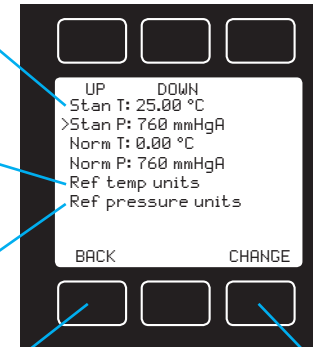

Ref temp units Changes the temperature units used for STP and NTP calculations.

Ref pressure units Changes the pressure units used for STP and NTP calculations.

BACK Returns to the Basic Configuration Menu (page 34).

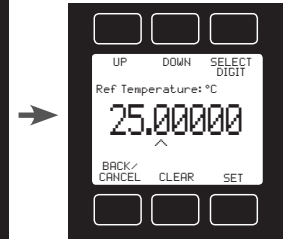

CHANGE Enters the value or unit selection screen for the selected parameter.

Defining STP/NTP Reference Values

Standardized flow rates are reported in "standard" or "normal" volumetric flow units that reference a given temperature and pressure combination (see "Actual vs Standardized Flow Readings" on page 23). This reference is called an STP (standard temperature and pressure) or, typically in Europe, an NTP (normal temperature and pressure).

The FP-25 ships with an Alicat default STP equivalent to the US EPA's, 25°C and 1 atm, and a default NTP of 0°C and 1 atm. Using the **STP/NTP** menu, you can change the temperature or pressure references for both STP and NTP separately. For example, you can change the NTP temperature reference to 15°C for use with IMPROVE network samplers.

To make changes, follow these steps:

1. Select the temperature or pressure reference you wish to change using the **UP** and **DOWN** buttons. Press **CHANGE**.
2. The current temperature or pressure value will appear. Change the value, or press **CLEAR** to restore the Alicat default. When ready, press **SET**.
3. At the confirmation screen, press **SET** again to confirm your desired change.

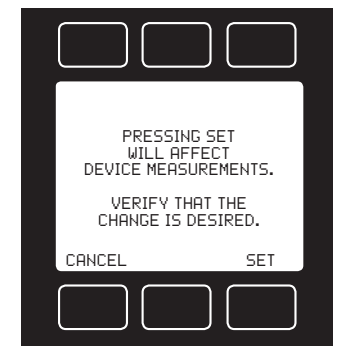

Navigating and Customizing Your FP-25

Advanced Setup

The Advanced Setup Menu leads to the following advanced functions:

- **SENSOR SETUP** sets sensor averaging and the zero band size (page 37).
- **COMM SETUP** sets up serial communications (page 39). Also allows you to toggle the Bluetooth antenna **ON** and **OFF** (FP-25BT only).
- **CLOCK SETUP** sets the date and time for the real-time clock (page 38).

In addition, the Advanced Setup Menu allows you to adjust the contrast of the FP-25 screen (**LCD CNTRST**).

Setup | Advanced Setup

SENSOR SETUP Enters the Sensor Setup Menu (page 37).

COMM SETUP Enters the Communications Menu (page 39).

LCD CNTRST Sets the contrast level of the FP-25 display. Use the **UP/DOWN** buttons to choose the contrast level up to a maximum of 31.

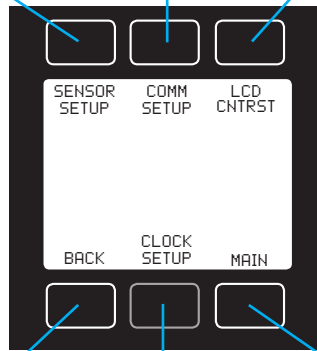

BACK Returns to the Setup Menu.

CLOCK SETUP Enters the Clock Setup Menu (page 38).

MAIN Returns to the **Instant** screen of Standard Mode or Basic Mode, whichever was last used.

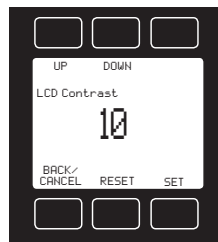

✔ **Note:** Increasing the number under **LCD CNTRST** increases the contrast level. The maximum contrast level is 31. Press **RESET** to revert to the default contrast level (10).

Navigating and Customizing Your FP-25

Advanced Setup | Sensor Setup

ZERO BAND Sets the deadband threshold (max 6.3% of full scale), under which flow values are displayed as 0.

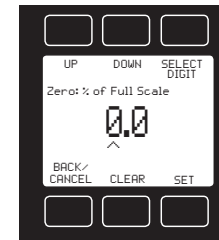

BACK Returns to the Advanced Setup Menu (page 36).

PRESS AVG Adjusts the length of the geometric running average (1-255 ms) for reported pressure values.

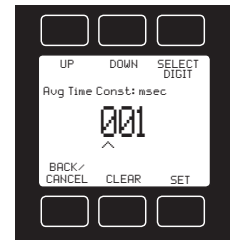

MAIN Returns to the **Instant** screen of Standard Mode or Basic Mode, whichever was last used.

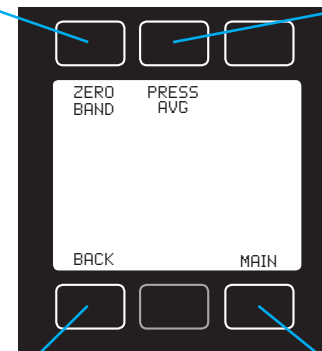

Sensor Setup

The **SENSOR SETUP** menu contains advanced settings that govern how the flow and pressure sensors report their data.

PRESS AVG changes the length of the geometric running average for pressure readings. Values roughly correspond to the time constant (in milliseconds) of the averaged values. Higher numbers generate a greater smoothing effect on quickly fluctuating readings (default is 255, full averaging).

ZERO BAND is the deadband threshold, a value below which the FP-25 displays all flow readings as 0 (no flow). This function also applies to gauge pressure readings from the internal pressure sensor. The FP-25 ships with a **ZERO BAND** value of 0.0%, which means that all flow values are reported, no matter how tiny. Increasing this value effectively chops off the bottom end of the device's flow range. This can be useful if you want to disregard all flow rates below the turndown range of the instrument, and so they display as zero flow.

✔ **Note:** **ZERO BAND** values do not affect the serial data frame.

Navigating and Customizing Your FP-25

Setting Up the Real-Time Clock

Your FP-25 contains an internal battery that powers its real-time clock when the power switch is off. You can set the date and time for this clock in the **CLOCK SETUP** menu.

Advanced Setup | Clock Setup

DATE Sets the year, month and day for the real-time clock.

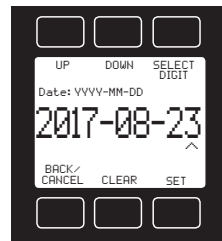

TIME Sets the hours, minutes and seconds for the real-time clock.

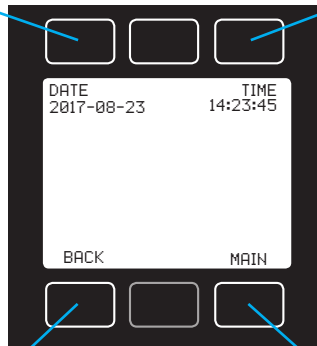

BACK Returns to the Advanced Setup Menu (page 36).

MAIN Returns to the **Instant** screen of Standard Mode or Basic Mode, whichever was last used.

Setting Up Serial or Bluetooth Communications

The COMM SETUP menu gives quick access to turning the Bluetooth antenna on or off (FP-25BT only) and to establishing wired serial communications.

Advanced Setup | Comm Setup

BLUETOOTH Turns the Bluetooth antenna **-ON-** and **-OFF-**.

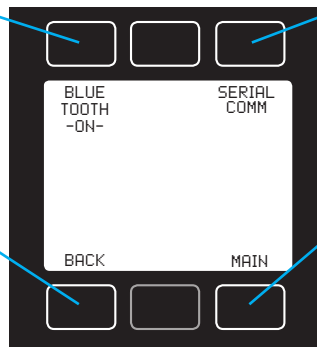

SERIAL COMM Enters the Serial Communications Menu (page 39).

BACK Returns to the Advanced Setup Menu (page 36).

MAIN Returns to the **Instant** screen of Standard Mode or Basic Mode, whichever was last used.

Navigating and Customizing Your FP-25

Comm Setup | Serial Comm

UNIT ID Sets the serial unit ID (see below):
 @ = streaming mode
 A-Z = polling mode

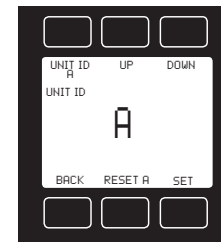

BAUD Sets the serial baud rate (see below). Baud rates include: 2400, 9600, 19200, 38400 and 57600.

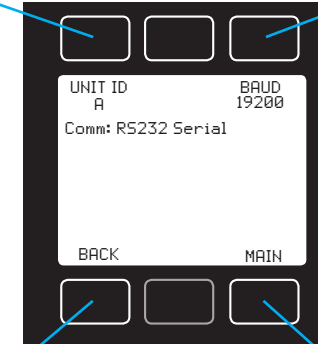
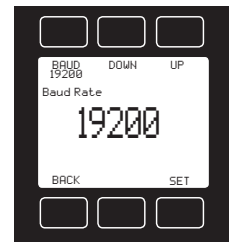

BACK Returns to the Communications Setup Menu (page 36).

MAIN Returns to the **Instant** screen of Standard Mode or Basic Mode, whichever was last used.

Configuring the FP-25 for Serial Communications

You can operate the FP-25 via its micro-USB connector for easy streaming and logging of all calibration data. Before connecting the FP-25 to a computer, ensure that it is ready to communicate with your PC by checking the options in the **SERIAL COMM** menu.

Unit ID

The unit ID is the identifier that a computer uses to distinguish your FP-25 from other devices when it is connected to a network. Using the unit ID letters **A-Z**, you can connect up to 26 devices to a computer at the same time via a single USB port. This is called polling mode (page 41). Unit ID changes take effect when you select **SET** and exit the menu system.

If you select @ as the Unit ID, the FP-25 enters streaming mode when you exit the menu (page 41).

Baud Rate

Baud rate is the speed at which devices transfer digital information. The FP-25 has a default baud rate of 19200 baud (bits per second). If your computer uses a different baud rate, you must change the FP-25 baud rate in the **BAUD** menu to match it. (Alternatively, you can change your PC's baud rate in Device Manager.) Use the **UP/DOWN** buttons to select 38400, 19200, 9600, or 2400 baud. Baud rate changes take effect immediately.

Serial Communications

Connecting your FP-25 to a computer allows you to log the data that it generates during a flow audit or calibration. You can also begin and record new timed measurements by issuing a simple command. The FP-25 communicates digitally through its top-mounted micro-USB port and cable, using a virtual COM port on your PC. This section of the manual shows you how to operate the FP-25 using ASCII commands.

Establishing Serial Communications

In most cases, all you need to do to connect your FP-25 to a computer is plug in the micro-USB cable to the port at the top of the device. Your computer will recognize the FP-25 as a COM port in the Device Manager of Windows. If it does not, you can download the USB device driver at alicat.com/drivers.

After you have connected the FP-25, open the Device Manager, and find the new virtual COM port. It should appear under the "Ports (COM & LPT)" category as "USB Serial Port (COM#)" as you see below:

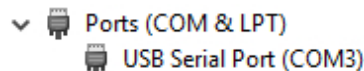

Write down the COM port number (COM3 in the example above).

Serial Terminal Application

Alicat's Serial Terminal is a preconfigured program for serial communications that functions much like the older HyperTerminal program of Windows. Download Serial Terminal for free at alicat.com/drivers. Once downloaded, simply run SerialTerminal.exe. Enter the COM port number you obtained from Device Manager and the baud rate of the FP-25. The default baud rate is 19200, but this is adjustable by entering the **SERIAL COMM** menu on your FP-25: **MENU > SETUP > ADV SETUP > COMM SETUP > SERIAL COMM > BAUD** (page 39).

✓ **Note:** *In what follows, <CR> indicates an ASCII carriage return (decimal 13, hexadecimal D). Serial commands are not case-sensitive.*

Setting Time and Date Serially

You can change the time and date stored by your FP-25's real-time clock by typing:

Set time and date: [unit ID] **mcs** [sec.] [min.] [hour] [day] [month] [year] **<CR>**
Example: **amcs 00 15 14 25 7 2017 <CR>**
(sets time to 2:15:00 pm, and date to 25 July 2017)

✓ **Note:** *Time on the FP-25 always appears in 24-hour format.*

Serial Communications

Serial Streaming vs Polling

Polling Mode

Your FP-25 was shipped to you in polling mode with a unit ID of A. Polling the FP-25 returns a single line of data each time you request it. To poll your FP-25, simply type the unit ID, and then press enter/return **<CR>**:

Poll the FP-25: [unit ID]**<CR>**
Example: **a<CR>** (polls unit A)

You can change the unit ID of a polling device by typing:

Change the unit ID: [current unit ID]**@=[desired unit ID]<CR>**
Example: **a@=b<CR>** (changes unit A to unit B)

You can also do this via the FP-25 menu: **MENU > SETUP > ADV SETUP > COMM SETUP > SERIAL COMM > UNIT ID** (page 39). Valid unit IDs are letters A-Z, and up to 26 devices may be connected at any one time as long as each unit ID is unique.

Streaming Mode

In streaming mode, your FP-25 continuously sends a line of live data at regular intervals without your having to request the data each time. This mode is not compatible with averaged measurements. Only one unit on a given COM port may be in streaming mode at a time.

To put your FP-25 into streaming mode, type:

Begin streaming: [unit ID]**@=@<CR>** or ***@=@<CR>**

This is equivalent to changing the unit ID to "@". To take the FP-25 out of streaming mode, assign it a unit ID (in this case, A) by typing:

Stop streaming: **@@=[desired unit ID]<CR>**
Example: **@@=a<CR>** (stops and assigns unit ID of A)

When sending a command to an FP-25 in streaming mode, the flow of data will not stop while the user is typing. This may also make the commands you type unreadable. If the device does not receive a valid command, it will ignore it. If in doubt, simply hit **<CR>** and start again.

✓ **Note:** *The default streaming interval is 50 ms, but this can be increased by changing Register 91 while the device is in polling mode:*

Set streaming interval: [unit ID] **w91=[number of milliseconds]<CR>**
Example: **aw91=500<CR>** (streams new data every 500 ms)

Taring Serially

Before collecting flow data, be sure to tare your FP-25. Whereas the front display has a single button that tares the device, this is accomplished serially through two separate commands. Taring volumetric flow sets the zero flow reading and must be done when no flow is passing through the FP-25:

Tare volumetric flow: [unit ID]v<CR>

Example: av<CR> (sets volumetric flow reading to zero)

The second tare aligns the internal absolute pressure sensor with the current barometer reading and must be done with the FP-25 open to atmosphere:

Tare absolute pressure: [unit ID]pc<CR>

Example: apc<CR> (aligns internal pressure to barometer)

Collecting Live Flow Data Serially

Collect live flow data by typing the [unit ID] <CR> command ,or by setting your FP-25 to streaming. Each line of data for live flow measurements appears in the format below, but Unit ID is not present in streaming mode.

A	000000	2017-07-25	0013:25:52	+13.54	-00.08	+704.0	+24.38	P	+16.667	+15.442	038	Air
Running Meas. ID	Date (yyyy-mm-dd)	Time (24 hr)	Absolute Pressure	Gauge Barometric	Temp Source	Ambient Volumetric	Standard (Mass)	Gas				
Unit ID	Date and Time		Pressure Data		Temperature	Flow Data		Humidity				

Single spaces separate each parameter, and each value is displayed in the chosen device engineering units, which may differ from the engineering units visible on the FP-25 display (see "Choosing Engineering Units from Standard Mode" on page 29). You can query the engineering units of the instant data frame by typing:

Query live data info: [unit ID]??d*<CR>

Example: a??d*<CR> (returns the data frame descriptions)

Additional columns, including status codes (see "Error Codes" on page 11), may be present to the right of the relative humidity column. The Unit ID appears in the data frame only when the FP-25 is in polling mode.

The temperature value is reported along with an indicator of its source: **P (Probe)** when the external temperature probe is used or **S (Stream)** when the probe is disconnected and the internal temperature sensor is being used.

 **Note: The Running Measurement ID indicates the status of averaged measurements. If no measurement is currently running, this value is 0. If a measurement is running, its new ID number appears here.**

Taking Averaged Measurements Serially

To begin or stop an averaged measurement, type:

Begin measurement: [unit ID]mb [duration in whole seconds]<CR>

Example: amb 5<CR> (begins a 5-second measurement)

Abort measurement: [unit ID]ma<CR>

Example: ama (cancels the measurement)

As usual, each second of measurement duration adds 1000 flow readings to the measurement average. When starting an averaged measurement serially, the measurement duration in the mb command does not overwrite the duration defined in MENU > SETUP > BASIC CONFIG > DEVICE UNITS > Average Time. To use this stored duration to take a timed measurement serially, type [unit ID]mb without a duration value, for example: amb<CR>.

When the measurement is complete, view the last measurement by typing:

Display measurement: [unit ID]md<CR>

Example: amd<CR> (displays current/last measurement)

While a measurement is still in progress, the md command above displays the running averages in progress and the time remaining.

A	000167	M	00:00:05	2017-07-25	0014:15:50	+13.54	-00.08	+704.0	+24.38	P	+16.723	+15.457	038	Air
ID	Status	Time	Remain	Date and Time	Time	Absolute Pressure	Gauge Barometric	Temp Source	Ambient Volumetric	Standard (Mass)	Gas			
Unit ID						Pressure Data		Temperature	Flow Data		Humidity			

Like the live data frame, temperature source can be **P (Probe)** or **S (Stream)**, but it can also be **M (Mixed)** if the probe was not connected the whole time. The measurement time remaining is reported along with an indicator of the measurement status: **M** while the measurement is in progress, **C** if it is complete or **A** if it has been aborted.

Query the engineering units of the averaged data frame by typing:

Query live data info: [unit ID]??dm*<CR>

Example: a??dm*<CR> (returns the data frame descriptions)

List all of the completed measurement IDs that are stored in your FP-25:

Display measurement: [unit ID]ms<CR>

Example: ams<CR> (lists all stored measurement IDs)

Review a specific completed measurement by including its ID number:

Display measurement: [unit ID]md [measurement ID]<CR>

Example: amd 167<CR> (displays stored measurement #167)

Serial Communications

Permanently erase one or more stored measurements by typing:

Erase measurement: [unit ID]me [measurement ID]<CR>
Example: ame 167<CR> (erases stored measurement #167)

Erase all: [unit ID]me<CR>
Example: ame<CR> (erases all stored measurements)

Quick Serial Command Guide

✓ *Note: Serial commands are not case-sensitive. For simplicity, we assume that the unit ID of the FP-25 is A in the listing that follows.*

Change the unit ID: [current unit ID]@[desired unit ID]<CR>
Set clock time and date: amcs [sec.] [min.] [hour] [day] [month] [year] <CR>

Tare volumetric flow: av<CR>
Tare abs. pressure with baro: apc<CR>

Poll the live data frame: a<CR>
Begin streaming data: [unit ID]@=@<CR> or *@=@<CR>
Stop streaming data: @@=[desired unit ID]<CR>
Set streaming interval: aw91=[number of milliseconds]<CR>

Begin measurement: amb [duration in seconds]<CR>
Abort current measurement: ama<CR>
Display current/last meas.: amd<CR>
Display measurement by ID: amd [measurement ID]<CR>
List all stored measurement IDs: ams<CR>
Delete all stored measurements: ame<CR>
Delete measurement by ID: ame [measurement ID]<CR>

Query manufacturer info: a??m*<CR>
Query live data info: a??d*<CR>
Query measurement info: a??dm*<CR>

Lock the front display: a1<CR>
Unlock the front display: au<CR>

Additional Serial Commands

If you have need of more advanced serial communication commands, please contact Alicat.

Bluetooth Communications (FP-25BT Only)

Climb ladders less by connecting an Android™ mobile device to your FP-25BT. This makes flow calibration easier and more efficient for air samplers that are housed inside climate-controlled shelters, including Met One's BAM series, Teledyne's T640 and Thermo Fisher's TEOM series. When you use the FP-25BT with Bluetooth, you can monitor all live flow data and begin averaged flow measurements without moving away from the display of your sampler.

Setting Up Bluetooth Communications

Preparing Your FP-25BT for Bluetooth Communications

Your FP-25BT uses Bluetooth Low Energy (BLE) with a long-range chipset and an externally mounted antenna to connect to your mobile device.

1. Connect the Bluetooth antenna. Your FP-25BT was shipped to you with a threaded cap installed in the place of the Bluetooth antenna. Unscrew this cap, and thread the antenna onto the exposed connector. The antenna and its base can each rotate 360°, allowing you to position it in any direction.

✓ *Note: You can keep the Bluetooth antenna connected when you store the FP-25BT in its carrying case. Simply point the antenna to the right, as shown.*



2. Confirm that Bluetooth is turned on. Enter the Communications Setup menu by selecting MENU > SETUP > ADV SETUP > COMM SETUP. Bluetooth status appears in the upper left corner of the screen. Press the button above it to toggle Bluetooth -ON- and -OFF-.

✓ *Note: There is no pairing process for the FP-25BT. Whenever Bluetooth is on, it is readily discoverable by any mobile device that has the Alicat Connect™ app.*

! *Caution: Battery life will be reduced somewhat when Bluetooth is on.*

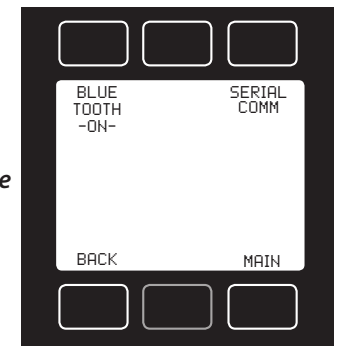

Bluetooth Communications (FP-25BT Only)

Preparing Your Mobile Device for Bluetooth Communications

Your FP-25BT uses an application called Alicat Connect™ to display its flow data wirelessly. This app is only compatible with Android™ mobile devices. If you do not have an Android device, we can recommend one for you.

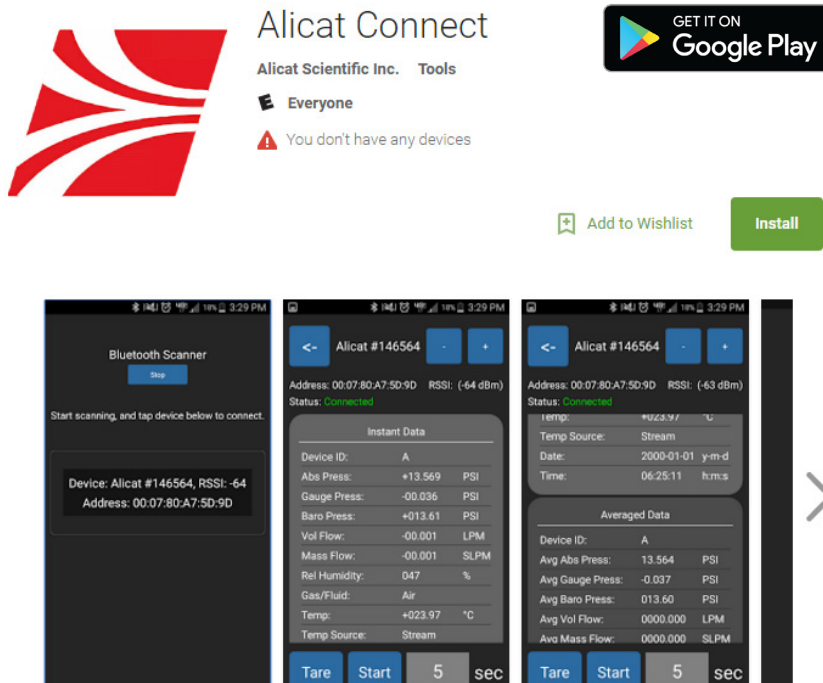

1. **Download and install Alicat Connect from Google Play™.** Your device must be running Android 5.0 or higher.
2. **Confirm that your Android device has Bluetooth turned on.** Enter the Settings menu on your device, and select Bluetooth to turn it on.

Preparing Your Air Monitoring Site for Bluetooth Communications

The Bluetooth antenna on your FP-25BT is powerful enough to broadcast its signal through the roof and walls of your air monitoring shed, even if it is built inside a steel shipping container. That said, Bluetooth signal strength will be highest when you can minimize the amount of metal, concrete and plaster that lie between your mobile device and the FP-25BT. Fluorescent lights, unshielded cabling and microwaves can also interfere with Bluetooth's 2.4 GHz radio frequency. Performance will also vary by mobile device, as mobile device manufacturers use a variety of internal Bluetooth antennas.

Bluetooth Communications (FP-25BT Only)

Using Alicat Connect™ with Your FP-25BT

Once you have Alicat Connect installed, you can access the app by tapping the Alicat logo in your device's "Apps" folder.

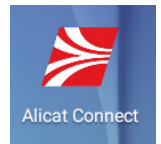

Connecting Alicat Connect to Your FP-25BT

The Alicat Connect app starts up at the Bluetooth Scanner screen.

Tap the blue **Start** button to begin scanning for your FP-25BT. When Alicat Connect has found an FP-25BT, it will display its serial number and model number, signal strength (RSSI) and Bluetooth address inside a black button. If you have more than one FP-25BT in range, each device's information will be displayed in its own box.

Tap the button of your desired FP-25BT to connect to it.

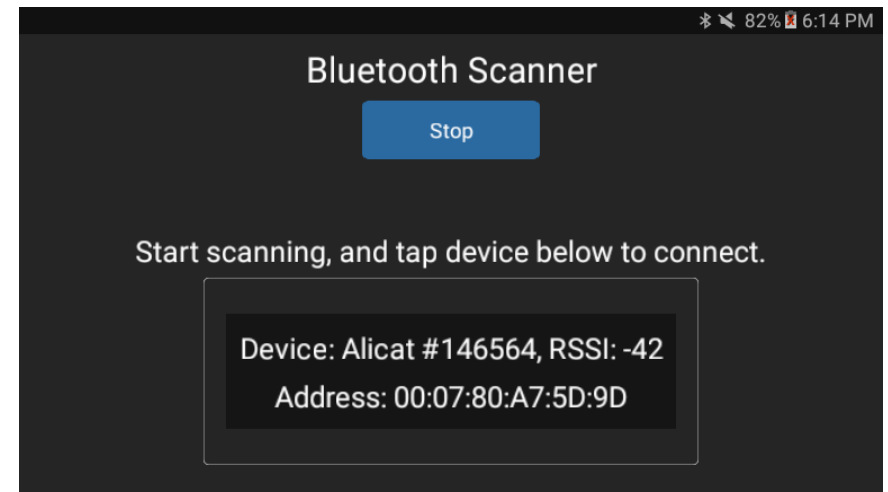

After successfully connecting to your FP-25BT, Alicat Connect shows the serial number at the top of the screen, along with the current signal strength and Bluetooth address. The **Status** indicator appears green while it is **Connected** to your FP-25BT; it turns red if the Bluetooth signal becomes **Disconnected**.

Tap the back arrow [←] to return to the scanning page.

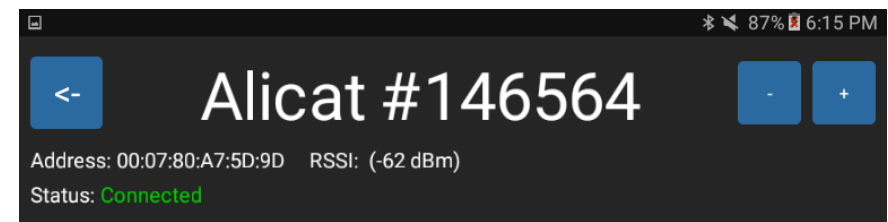

Bluetooth Communications (FP-25BT Only)

Navigating the Alicat Connect Main Display

Back [-] Returns to the Bluetooth Scanner. Zoom [-/+] Enlarges [+] or reduces [-] the data display.

Alicat #146564

Address: 00:07:80:A7:5D:9D RSSI: (-62 dBm)
 Status: **Connected**

Instant Data			Averaged Data		
Device ID:	A		Device ID:	A	
Abs Press:	+13.557	PSI	Avg Abs Press:	13.591	PSI
Gauge Press:	-00.041	PSI	Avg Gauge Press:	-0.033	PSI
Baro Press:	+013.60	PSI	Avg Baro Press:	013.63	PSI
Vol Flow:	+00.000	LPM	Avg Vol Flow:	0000.000	LPM
Mass Flow:	+00.000	SLPM	Avg Mass Flow:	0000.000	SLPM
Rel Humidity:	047	%	Avg Rel Humidity:	038	%
Gas/Fluid:	Air		Gas/Fluid:	Air	
Temp:	+023.73	°C	Avg Temp:	024.09	°C
Temp Source:	Stream		Avg Temp Source:	Stream	
Date:	2000-01-01	y-m-d	Date:	2000-01-01	y-m-d
Time:	06:11:02	h:m:s	Time:	02:48:53	h:m:s
			Meas Status:	Completed	
			Meas Time Remain:	0:00:00	h:m:s
			Meas ID:	000105	

Tare **Start** **5** sec

Tare Zeroes the flow value. (Same as selecting **MENU > TARE** on your FP-25T.)

Start Begins an averaged measurement (**START AVG**)

sec Displays the selected duration of the averaged measurement. Tap to change. (**MENU > SETUP > BASIC CONFIG > AVG TIME**)

Bluetooth Communications (FP-25BT Only)

Monitoring Instant Data with Alicat Connect

! *Caution: Remember to tare your FP-25BT before beginning your flow calibration process. Ensure your air sampler or analyzer pump is off, and then tap the blue Tare button at the bottom of Alicat Connect.*

The Instant Data table displays the same data that appears on the **Instant** screen of your FP-25BT. All of the data within this table is generated by the FP-25BT itself, not your mobile device. You can verify that live data is streaming to the mobile device by looking for small changes in flow values.

✓ *Note: Alicat Connect's data refresh rate is somewhat slower than the display of your FP-25BT. Your observed refresh rate depends on the strength of your Bluetooth signal (RSSI). A 10 dBm increase in RSSI is equivalent to a ten-fold increase in signal strength, so a -70 dBm signal is 10x stronger than -80 dBm, and 100x stronger than -90 dBm.*

Collecting Averaged Data with Alicat Connect

Averaged measurements work the same way in Alicat Connect as they do on your FP-25BT. Tap **Start** in Alicat Connect (same as **START AVG** on the FP-25BT) to begin a measurement. Tap **Abort** (same as **CANCEL AVG**) to cancel it.

The actual calculation of averaged measurements occurs on your FP-25BT, and averaged readings are updated in real time within Alicat Connect, as long as your signal is strong enough. If your mobile device loses its connection to your FP-25BT during a timed measurement, the FP-25BT will still complete its measurement and then transmit the measurement data to your mobile device if it has reconnected.

You can set the duration of each averaged measurement by tapping the number in the seconds box (**sec**). Convert measurement times that are longer than a minute into seconds only, and then tap **Done** to accept.



When you tap **Start** to begin an averaged measurement, the seconds box (**sec**) darkens and counts down to zero. This countdown also appears in the Averaged Data table next to **Meas Time Remain**.

Averaged measurements that you begin in Alicat Connect are also added to the Stored Averages log on your FP-25BT. New measurements in Alicat Connect replace previous measurement data shown on the screen, but each measurement's unique ID (**Meas ID**) appears in the Averaged Data table. You can review previous averages on your FP-25BT directly by finding the same **ID** inside the Stored Averages listings (**MENU > STORED AVGS > VIEW**).

Standard Operating Procedures (SOPs)

The following pages contain example Standard Operating Procedures (SOPs) for using the FP-25 to evaluate the performance of particulate matter air samplers, whether PM₁₀, PM_{2.5} or some other type. PM air sampler manuals typically define separate procedures for audits, calibrations or performance checks. Overall, the operation of the FP-25 is the same, whether the data is being obtained for a field performance check, audit or annual calibration. However, relevant differences between such procedures will be noted.

The table below is a quick reference for identifying which FP-25 SOPs can be used with various samplers. This is not an exhaustive list.

Air Samplers	SOPs	Ambient Temp (page 51)	Filter Temp (page 53)	Ambient Pressure (page 55)	Leak Check in Direct Mode (page 56)	Flow in Direct Mode (page 59)	Flow in Standard Mode (page 63)
PM ₁₀ and PM _{2.5} FRM samplers (16.7 lpm) Mesa Labs PQ series, Met One E-FRM, Thermo Scientific Partisol 2000/2025(i) and Dichots, Tisch TE-Wilbur	✓	✓	✓	✓	✓	✓	✓
PM ₁₀ and PM _{2.5} FEM analyzers (16.7 lpm) Environnement S.A. MP101M, Met One BAM-1020/1022 and E-BAM, Thermo Scientific BAM 5014i, SHARP 5030i and TEOM 1400(a/ab)/ 1405 and Dichots	✓			✓	✓	✓	✓
IMPROVE network PM samplers (22.8 lpm)	✓			✓	✓	✓	✓
Low-flow PM samplers (1-5 lpm) Ecotech MircoVol and Protinus, Grimm EDM, Met One E-Sampler	✓			✓			✓
Carbon speciation samplers (22.0 lpm) URG-3000(N)	✓			✓	✓	✓	✓
Carbon speciation samplers (6.7 lpm) Met One SASS and SuperSASS	✓			✓			✓
Black carbon analyzers (1-5 lpm) Magee Aethalometer, Met One BC-1050	✓			✓			✓

Standard Operating Procedures (SOPs)

Verifying Ambient Air Temperature

1. Prepare the air sampler. Place your air sampler into Audit or Calibration Mode following the instructions in the sampler's manual.

2. Prepare the FP-25.

2.1 Ensure that the FP-25 external temperature probe is connected to the FP-25. When the external temperature probe has been inserted correctly, the word **Probe** will flash on the right side of the display, alternating with the relative humidity value. See "Connecting the External Temperature Probe to Your FP-25" on page 13 for details.



2.2 Confirm that °C is the displayed engineering unit for temperature. If it is not, press the button above the temperature display, once to highlight temperature in the center of the screen, and then a second time to enter the unit selection menu. Select **Set button eng units** to change the engineering unit on the display only. Select **Set device eng units** to change the unit on the display and in the serial data frame. Use the **UP** and **DOWN** keys to move the > cursor to °C, and then press **SET**.

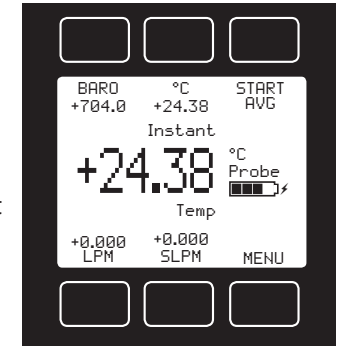

2.3 Confirm that the temperature probe has equilibrated to ambient air temperature. If the probe has previously been sitting in direct sunlight, allow a minute or two for the temperature reading to settle at the new temperature.

3. Verify the sampler's reported ambient air temperature.

3.1 Position the end of the FP-25 temperature probe within 1 inch of the ambient temperature sensor of the air sampler.

» If the sampler's ambient temperature sensor is housed inside a radiation shield, insert the FP-25 probe into the lowest layer of the sampler's radiation shield, locating the probe's tip as close as possible to the sensor at the middle of the radiation shield.

Caution: Some samplers have metal radiation shields. Take care not to let the tip of the FP-25 temp probe rest against this metal.

Standard Operating Procedures (SOPs)

Verifying Ambient Air Temperature



✓ **Note:** The FP-25 external temperature probe is submersible up to its handle. If your sampler's manual instructs you to remove its ambient temperature sensor from its radiation shield and immerse it with a temperature standard into a liquid bath, you may use the FP-25 temp probe to do so. Be sure to keep the liquid at least 1 inch (2.4 cm) away from the handle of the FP-25 external temperature probe.

» If the sampler has no radiation shield, place the FP-25 probe in the shade in the immediate vicinity of the sampler.

3.2 Verification or audit: Compare the sampler and FP-25 readings.

Is the sampler's displayed ambient temperature reading within 2°C of the temperature displayed by the FP-25?

» If yes, proceed to verifying the filter temperature (if specified by your air sampler's manual).

» If no, calibrate the sampler.

3.3 Calibration: Enter the FP-25 temperature value into the sampler.

3.4 Record your data.

Standard Operating Procedures (SOPs)

Verifying Filter Temperature

1. **Prepare the air sampler.** Place your air sampler into Audit or Calibration Mode following the instructions in the sampler's manual.

2. Prepare the FP-25.

2.1 **Ensure that the FP-25 external temperature probe is connected to the FP-25.** When connected, the word **Probe** will flash on the right side of the display, alternating with the relative humidity value. See "Connecting the External Temperature Probe to Your FP-25" on page 13 for details.



2.2 **Confirm that °C is the displayed engineering unit for temperature.** If it is not, press the button above the temperature display, once to highlight temperature in the center of the screen, and then a second time to enter the unit selection menu. Select **Set button eng units** to change the engineering unit on the display only. Select **Set device eng units** to change the unit on the display and in the serial data frame. Use the **UP** and **DOWN** keys to move the > cursor to °C, and then press **SET**.

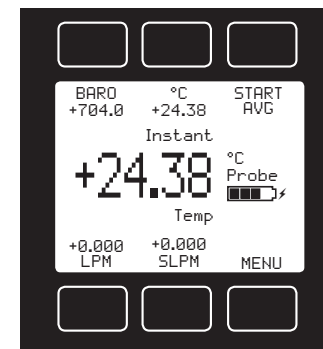

2.3 **Confirm that the temperature probe has equilibrated to ambient air temperature.** If the probe has been sitting in direct sunlight, allow a minute or two for the temperature reading to settle.

3. Verify the sampler's reported ambient air temperature.

3.1 **Position the end of the FP-25 temperature probe within 1 inch of the filter temperature sensor of the air sampler.**



Standard Operating Procedures (SOPs)

Verifying Filter Temperature

3.2 Verification or audit: Compare the sampler and FP-25 readings.

Is the sampler's displayed filter temperature reading within 2°C of the temperature displayed by the FP-25?

- » If yes, proceed to verifying the ambient pressure.
- » If no, calibrate the sampler.

3.3 Calibration: Enter the FP-25 temperature value into the sampler.

3.4 Record your data.

3.5 If your sampler has more than one filter temperature probe, repeat Step 3 of this procedure for each probe.

✓ *Note: Many sampler verification or audit SOPs include a procedure for verifying the accuracy of the sampler's relative humidity sensor. The FP-25's ambient humidity sensor cannot be used for this verification because its accuracy of ±3.5% (percentage points of the measured RH reading) does not satisfy the EPA-required accuracy of ±2%.*

Standard Operating Procedures (SOPs)

Verifying Ambient Pressure

1. **Prepare the air sampler.** Place your air sampler into Audit or Calibration Mode following the instructions in the sampler's manual.

2. Prepare the FP-25.

2.1 **Confirm that the FP-25 is displaying barometric pressure.** When the FP-25 is displaying barometric pressure, the word **BARO** will appear above the pressure value at the top left of the screen in Standard Mode, or to the right of the pressure value in Basic Mode. To view barometric pressure, touch the button above the pressure display in Standard Mode twice and select **Show baro pressure**.

2.2 **Confirm that mmHg is the displayed engineering unit for barometric pressure.** In Standard Mode, you can verify the barometric pressure units by pressing the button above the pressure display just once to highlight pressure in the center of the screen. The engineering unit displayed to the right of the pressure value should read **mmHgA**.



» To change the pressure engineering units, press the button above the pressure display a second time to enter the unit selection menu. Select **Set button eng units** to change the engineering unit on the display only. Select **Set device eng units** to change the unit on the display and in the serial data frame. Use the **UP** and **DOWN** keys to move the > cursor to **mmHgA @ 0°C**, and then press **SET**.

✓ *Note: The FP-25 external temperature probe does not affect barometric pressure measurements, so it may be either connected or disconnected during ambient pressure verification procedures.*

3. Verify the sampler's reported ambient pressure.

3.1 **Verification or audit: Compare the sampler and FP-25 readings.** Is the sampler's displayed ambient pressure reading within 10 mmHg of the temperature displayed by the FP-25?

- » If yes, perform the external leak check.
- » If no, calibrate the sampler.

3.2 Calibration: Enter the FP-25 pressure value into the sampler.

3.3 Record your data.

Standard Operating Procedures (SOPs)

Verifying Internal Pressure during Leak Checks

✓ **Note:** The FP-25 can verify sub-atmospheric pressures during external leak checks of air samplers. This procedure works only for samplers that have standard 1.25" downtubes or adapters for this tube size.

1. Prepare the air sampler. Place your air sampler into External Leak Check Mode following the instructions in the sampler's manual. The sampler manual may require you to install a new filter for this procedure.

1.1 If the FP-25 is not already connected to the sampler, remove the PM₁₀ inlet from the sampler's downtube.

1.2 If the FP-25 is already connected to the sampler in Direct Mode, simply replace the PM₁₀ inlet with the sampler's leak check adapter, sliding it over the end of the FP-25's PM inlet adapter.

2. Prepare the FP-25.

2.1 Set the internal pressure engineering units to match the unit used by your air sampler when performing leak checks.

» To change the pressure engineering units from Standard Mode, press the button above the pressure display a second time to enter the unit selection menu. Select **Set button eng units** to change the engineering unit on the display only. Select **Set device eng units** to change the unit on the display and in the serial data frame.

» To change the pressure engineering units from the Menu, select **MENU > SETUP > BASIC CONFIG > DEVICE UNITS**. Select **Pressure** to change the units for internal pressure readings.

2.2 Rotate the screen by selecting **MENU > BASIC MODE** and then selecting **ROTATE** to rotate the screen.

2.3 Locate the internal pressure readings. Readings for internal stream pressure appear third in the list of readings and are appended with the letter **A** for absolute pressure (e.g. mmHgA or PSIA) and the letter **G** for gauge pressure (e.g. mmHgG or PSIG).

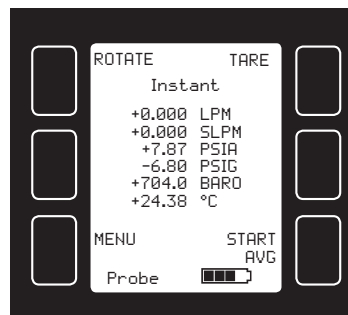
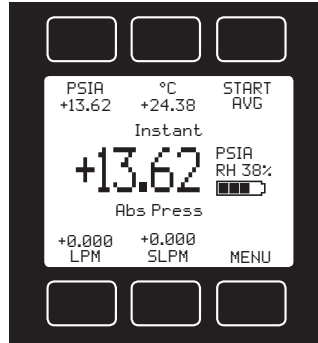

Standard Operating Procedures (SOPs)

Verifying Internal Pressure during Leak Checks

2.4 Attach the Direct Mode adapters to the FP-25. Connect the larger downtube adapter to the right (outlet) side of the FP-25, and the smaller PM inlet adapter to the left (inlet) side. See "Connecting Your FP-25 to an Air Sampler" on page 14 for details.



⚠ **Caution:** Each of the supplied fittings has an embedded face seal, so do not apply Teflon tape, pipe dope or sealant to the threads. These compounds can damage the FP-25 if they get into the flow stream.

2.5 Mount the FP-25 to the sampler's downtube, or to the PM_{2.5} cyclone, if used. The downtube adapter of the FP-25 should fit snugly.

2.6 Place the leak check adapter (flow audit adapter) on top of the FP-25, sliding it over the end of the FP-25's PM inlet adapter.

✓ **Note:** The FP-25 external temperature probe does not affect internal pressure measurements, so it may be either connected or disconnected during external leak check pressure verification procedures.



3. Perform the sampler external leak check procedure. Consult your air sampler manual for instructions. Be sure to close the valve on the leak check adapter when instructed.

3.1 Compare the sampler and FP-25 pressure readings during the leak check. Did the sampler pass its external leak check?

» If yes, proceed to verifying the flow rate.

» If no, identify the source of the leak.

3.2 Identify the source of any leaks. The FP-25 pressure readings can help diagnose failed external leak checks.

» If the internal flow stream pressure reported by the FP-25 (in absolute or gauge units) did not drop significantly, then the sampler's pump may not have achieved its target partial vacuum, and the sampler may have a large leak. Check the filter cassette for bad seals or misalignment. Check the

Standard Operating Procedures (SOPs)

Verifying Internal Pressure during Leak Checks

downtube and FP-25 fittings to ensure all components are fully seated.

» If the internal flow stream pressure reported by the FP-25 (in absolute or gauge units) did not drop properly, roughly matching the pressure values reported by the sampler, then there may be a smaller internal leak. Conduct the internal leak check to diagnose further.

» If the FP-25 showed significant flow during the leak check, then there may be a leak through the leak check adapter or its valve. Ensure both the FP-25 and the leak check adapter are firmly connected to each other and the downtube. Verify that the valve of the leak check adapter is closed.

✔ **Note:** During leak checks in Direct Mode, the FP-25 will provide flow readings in addition to pressure readings, but these are not comparable to any flow readings reported by the sampler. Whereas the sampler is measuring flow at the end of the flow path, the FP-25's location right after the closed valve on the leak check adapter prevents it from providing meaningful flow measurements during leak checks.

3.3 **Open the valve on the leak check adapter when instructed.**

3.4 **Record your data.**

Standard Operating Procedures (SOPs)

Verifying Flow Rates in Direct Mode

✔ **Note:** This procedure works only for samplers that have standard 1.25" downtubes or adapters for this tube size. If yours does not, please use the alternate procedure, "Verifying Flow Rates in Standard Mode" on page 63.

✔ **Note:** Verify sampler temperature (page 51) and pressure (page 55) readings, and check for leaks (page 56), before verifying flow rates. Poor performance in any one of these areas can be the root cause for bad flow readings during flow verification.

1. Prepare the FP-25.

1.1 **Ensure that the external temperature probe is connected to the FP-25.** When connected, the word **Probe** will flash on the right side of the display, alternating with the relative humidity value. See "Connecting the External Temperature Probe to Your FP-25" on page 13 for details.



1.2 **Confirm that LPM and SLPM are the displayed engineering units for flow.** To change the flow engineering units from the Menu, select **MENU > SETUP > BASIC CONFIG > DEVICE UNITS**. Select **Volumetric Flow** or **Standard Mass Flow** to change the units. Use the **UP** and **DOWN** keys to move the > cursor to **LPM** or **SLPM**, and then press **SET**.

✔ **Note:** The FP-25 ships with a default STP (standard temperature and pressure) of 25°C and 1 atm for standardized (mass) flow readings, which matches the US EPA's standard. This STP reference can be changed to correct to the IMPROVE network mean temperature (15°C). To make this change, select **MENU > SETUP > BASIC CONFIG > STP/NTP**. To use an NTP reference (normal temperature and pressure, typically 0°C and 1 atm), simply select **NLPM** as your engineering unit for flow.

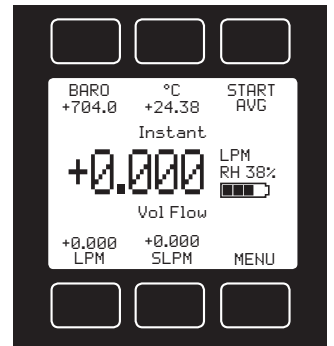

1.3 **If desired, set up the averaging timer.** Select **MENU > SETUP > BASIC CONFIG > AVG TIME** to set the duration of averaged measurements, from 1 second to as long as 10 hours. The FP-25 will add 1000 measurements to the average for each second.

1.4 **Prepare the FP-25 for Direct Mode by selecting MENU > BASIC MODE > ROTATE.** This orients the FP-25 screen 90 degrees counter-clockwise.

Standard Operating Procedures (SOPs)

Verifying Flow Rates in Direct Mode

1.5 **Tare the FP-25** by pressing **TARE**. Do this before you connect the FP-25 to the air sampler, ensuring that no air is flowing through it. If the FP-25 is already mounted on top of the sampler in Direct Mode after a leak check, be sure to tare it before you restart the sampler's pump.

✓ **Note:** *The FP-25 is sensitive enough to detect the lightest of breezes, so tare it with one end plugged and the other open to atmosphere.*

1.6 **Attach the Direct Mode adapters to the FP-25.** Connect the larger downtube adapter to the right (outlet) side of the FP-25, and the smaller PM inlet adapter to the left (inlet) side. See "Direct Mode connections to air samplers with 1.25" downtubes" on page 16 for details.

! **Caution:** *Each of the supplied fittings has an embedded face seal, so do not apply Teflon tape, pipe dope or sealant to the threads. These compounds can damage the FP-25 if they get into the flow stream.*

2. Mount the FP-25 beneath the PM₁₀ inlet.

2.1 **If the FP-25 is not already connected in Direct Mode**, remove the PM₁₀ inlet from the downtube.

» Connect the larger downtube adapter to the right (outlet) side of the FP-25, and the smaller PM inlet adapter to the left (inlet) side.

» Mount the FP-25 to the top of the sampler downtube, or the top of the PM_{2.5} cyclone if you are using one. The downtube adapter of the FP-25 should fit snugly over the downtube.

» Place the PM₁₀ inlet on top of the FP-25, sliding it over the end of the FP-25's PM inlet adapter.

2.2 **If the FP-25 is already in Direct Mode after a leak check**, simply replace the leak check adapter with the sampler's PM₁₀ inlet.

3. **Position the FP-25 external temperature probe.** Insert the temp probe into the sampler's radiation shield, and leave it in position during flow measurement. If the sampler has no radiation shield, place the temp probe in the shade in the immediate vicinity of the sampler.



Standard Operating Procedures (SOPs)

Verifying Flow Rates in Direct Mode

! **Caution:** *The FP-25 uses its external temp probe to provide actual (volumetric) flow measurements. Ensure that the temp probe is not left in direct sunlight, where its readings can become artificially elevated.*

! **Caution:** *Some samplers have metal radiation shields. Take care not to let the tip of the FP-25 temp probe rest against this metal.*

4. **Prepare the air sampler.** Place your air sampler into Audit or Calibration Mode following the instructions in the sampler's manual. The sampler manual may require you to install a new filter for this procedure.

✓ **Note:** *Allow the sampler's internal flow controllers sufficient time to warm up, as directed in the sampler's manual. Some thermal mass flow controllers require 15-30 minutes to achieve full accuracy.*

5. **Conduct the sampler's flow verification or calibration procedure.** Consult your air sampler manual for instructions.

✓ **Note:** *Take care to distinguish between actual (volumetric) flow rates and standardized (mass) flow rates. In Basic Mode, volumetric flow is displayed above standardized flow.*

5.1 **Monitor live flow readings until the sampler flow rate settles.** When the FP-25 shows **Instant** at the top of the screen in Basic Mode, the FP-25 is providing live flow readings. If flow is stable, you can use these readings to verify the actual volumetric or standardized flow rates.

5.2 **Capture an averaged reading.** When live flow readings are unstable, on account of pump or flow controller oscillations, take an averaged reading. Select **START AVG** at the bottom right of the live display in Direct Mode. The averages are updated live during the measurement. While the measurement is running, the timer displays the remaining measurement time at the bottom left of the screen.

» The screen will display **Final Avg** at the top when the averaged measurement has finished. Select **INST/MENU** to resume live readings

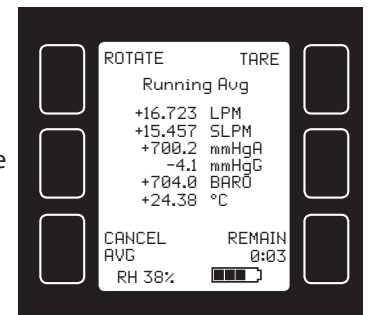

✓ **Note:** *The averaging function records averaged readings of all flow data, including temperature and pressure.*

Standard Operating Procedures (SOPs)

Verifying Flow Rates in Direct Mode

5.3 Verification or audit: Compare the sampler and FP-25 readings. Is the sampler's displayed volumetric or standardized flow reading within 2% of the flow rate displayed by the FP-25?

- » If yes, flow verification is complete.
- » If no, calibrate the sampler.

5.4 Calibration: Enter the FP-25 flow value into the sampler for each calibration point. Many air samplers use a 3-point flow calibration with readings at the nominal flow rate (e.g. 16.7 lpm), 10% below the nominal rate (e.g. 15.0 lpm for a 16.7 lpm sampler) and 10% above the nominal rate (e.g. 18.4 lpm for a 16.7 lpm sampler). Some require 5 calibration points.

5.5 Record your data.

6. Tare the FP-25 before calibrating the next sampler. Ensure that no air is flowing through the device, and one end is open to atmosphere. When ready, select **MENU > TARE**.

Standard Operating Procedures (SOPs)

Verifying Flow Rates in Standard Mode

✓ **Note:** This procedure is compatible with all air samplers.

✓ **Note:** Perform all sampler temperature, pressure and leak checks before verifying flow rates. Poor performance in any one of these areas can be the root cause for bad flow readings during flow verification.

1. Prepare the FP-25.

1.1 Ensure that the external temperature probe is connected to the FP-25. When connected, the word **Probe** will flash on the right side of the display, alternating with the relative humidity value. See "Connecting the External Temperature Probe to Your FP-25" on page 13 for details.



1.2 Confirm that LPM and SLPM are the displayed engineering units for flow. If they are not, press the button below the flow display you wish to change, once to highlight flow in the center of the screen, and then a second time to enter the unit selection menu. Select **Set button eng units** to change the engineering unit on the display only. Select **Set device eng units** to change the unit on the display and in the serial data frame. Use the **UP** and **DOWN** keys to move the > cursor to **LPM** or **SLPM**, and then press **SET**.

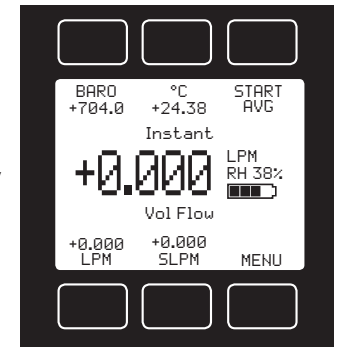

✓ **Note:** The FP-25 ships with a default STP (standard temperature and pressure) of 25°C and 1 atm for standardized (mass) flow readings, which matches the US EPA's standard. This STP reference can be changed to correct to the IMPROVE network mean temperature (15°C). To make this change, select **MENU > SETUP > BASIC CONFIG > STP/NTP**. To use an NTP reference (normal temperature and pressure, typically 0°C and 1 atm), simply select **NLPM** as your engineering unit for mass flow.

1.3 If desired, set up the averaging timer. Select **MENU > SETUP > BASIC CONFIG > AVG TIME** to set the duration of averaged measurements, from 1 second to as long as 10 hours. The FP-25 will add 1000 measurements to the average for each second.

Standard Operating Procedures (SOPs)

Verifying Flow Rates in Standard Mode

1.4 Tare the FP-25 by selecting **MENU > TARE**. Do this before you connect the FP-25 to the air sampler, ensuring that no air is flowing through it. If the FP-25 is already mounted on top of the sampler in Direct Mode after a leak check, be sure to tare it before you restart the sampler's pump.

✔ **Note:** *The FP-25 is sensitive enough to detect the lightest of breezes, so tare it with one end plugged and the other open to atmosphere.*

1.5 Keep the FP-25 in Standard Mode (MENU > STNDRD MODE) for this procedure. In Standard Mode, the FP-25 screen is upright.

1.6 Attach the barb fitting and tubing to the FP-25. Thread the supplied barb fitting into the right (outlet) side of the FP-25. Then fit one end of the supplied silicone tubing over the barb. See "Standard Mode connections to air samplers via the barb fitting" on page 15 for details.

⚠ **Caution:** *Each of the supplied fittings has an embedded face seal, so do not apply Teflon tape, pipe dope or sealant to the threads. These compounds can damage the FP-25 if they get into the flow stream.*



2. Connect the FP-25 to your sampler, according to the sampler type:

2.1 FRM or FEM sampler with a standard 1.25" downtube: Remove the PM₁₀ inlet from the downtube. Then attach the sampler's flow audit adapter (also called a leak check adapter) to the top of the downtube or PM_{2.5} cyclone, if used. Fit the other end of the tubing onto the end of the flow audit adapter's barb fitting.

2.2 Sampler with a larger downtube (IMPROVE or URG-3000): Remove the sampling inlet from the downtube. Then attach the sampler's 1.25" downtube adapter and the standard 1.25" flow audit adapter (also called a leak check adapter) to the top of the downtube. Fit the other end of the tubing onto the end of the flow audit adapter's barb fitting.



Standard Operating Procedures (SOPs)

Verifying Flow Rates in Standard Mode

2.3 SASS or SuperSASS: Fit the other end of the tubing into the individual filter's sampling inlet port. The outside diameter of the supplied silicone tubing is just the right size to create a seal against the inside surface of the inlet port.

2.4 Sampler with a low flow rate (1-5 lpm): You may need to adapt the smaller inlet diameter of the downtube to accommodate a minimum 0.25" standard barb fitting. Remove any screen that surrounds the inlet, and then connect the inlet adapter to the other end of the supplied silicone tubing.

» See "Standard Mode connections to air samplers via the barb fitting" on page 15 for more details.

3. Position the FP-25 external

temperature probe. Insert the temp probe into the sampler's radiation shield, and leave it in position during flow measurement. If the sampler has no radiation shield, place the temp probe in the shade in the immediate vicinity of the sampler



⚠ **Caution:** *The FP-25 uses its external temp probe to provide actual volumetric flow measurements. Ensure that the temp probe is not left in direct sunlight, where its readings can become artificially elevated.*

⚠ **Caution:** *Some samplers have metal radiation shields. Take care not to let the tip of the FP-25 temp probe rest against this metal.*

4. Prepare the air sampler. Place your air sampler into Audit or Calibration Mode following the instructions in the sampler's manual. The sampler manual may require you to install a new filter for this procedure.

✔ **Note:** *Allow the sampler's internal flow controllers sufficient time to warm up, as directed in the sampler's manual. Some thermal mass flow controllers require 15-30 minutes to achieve full accuracy.*

5. Conduct the sampler's flow verification or calibration procedure. Consult your air sampler manual for instructions.

✔ **Note:** *Take care to distinguish between actual (volumetric) flow rates and standardized (mass) flow rates. In Standard Mode, volumetric flow is displayed to the left of standardized flow at the bottom of the screen. You can highlight either one of these values in the center of the screen by pushing the button that lies underneath it.*

5.1 Monitor live flow readings until the sampler flow rate settles.

When the FP-25 shows **Instant** at the top of the screen in Standard Mode, the FP-25 is providing live flow readings. If flow is stable, you can use these

Standard Operating Procedures (SOPs)

Verifying Flow Rates in Standard Mode

readings to verify the actual volumetric or standardized flow rates.

5.2 Capture an averaged reading.

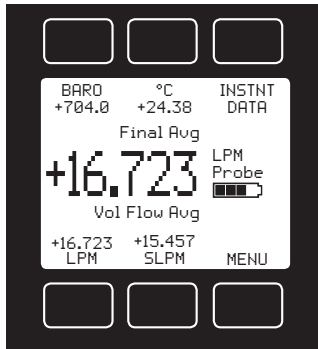

on account of pump or flow controller oscillations, take an averaged reading. Select **START AVG** at the top right of the live display in Standard Mode. The averages are updated live as the measurement runs. While the measurement is running, the timer displays the remaining measurement time at the bottom right of the screen.

» The screen will display **Final Avg** at the top when the averaged measurement has finished. Select **INST/MENU** to resume live readings.

✔ **Note: The averaging function records averaged readings of all flow data, including temperature and pressure readings.**

5.3 Verification or audit: Compare the sampler and FP-25 readings.

Is the sampler's displayed actual volumetric or standardized flow reading within 2% of the flow rate displayed by the FP-25?

- » If yes, flow verification is complete.
- » If no, calibrate the sampler.

5.4 Calibration: Enter the FP-25 flow value into the sampler for each calibration point. Many air samplers use a 3-point flow calibration with readings at the nominal flow rate (e.g. 16.7 lpm), 10% below the nominal rate (e.g. 15.0 lpm for a 16.7 lpm sampler) and 10% above the nominal rate (e.g. 18.4 lpm for a 16.7 lpm sampler). Some require 5 calibration points.

5.5 If you are auditing a SASS or SuperSASS, repeat Step 2.3 and all of Steps 4 and 5 of this procedure for each canister you are verifying.

5.6 Record your data.

6. Tare the FP-25 before calibrating the next sampler. Ensure that no air is flowing through the device, and one end is open to atmosphere. When ready, select **MENU > TARE**.

Alicat FP-25 Field Performance Check Sheet

Use this Field Performance Check Sheet to record your temperature, pressure and flow data during field verifications or audits.

Date: _____

Time: _____

Site Name/Identification: _____

Sampler Model: _____ Sampler ID: _____

Filter ID: _____

	Sampler Indicated	Alicat Measured	Pass/Fail
Ambient Temperature	°C	°C	
Filter Temperature	°C	°C	
Barometric Pressure	mmHg	mmHg	
Flow Rate (actual)	lpm	lpm	
Flow Rate (standard)	slpm	slpm	

Averaging time (1,000 measurements per second): _____ sec.

Percent difference

$$\frac{\text{Indicated Flow Rate} - \text{Measured Flow Rate}}{\text{Measured Flow}} \times 100 = \text{_____} \% \text{ Error}$$

Operator Signature: _____

Date: _____

Troubleshooting Your FP-25

General Use

Issue: *My Alicat does not turn on.*

Action: The FP-25 runs on a rechargeable battery, but you can also connect it to a wall outlet or computer using the included micro-USB cable. If the battery has been fully depleted, it may take a minute or so to acquire enough charge to turn back on. If your FP-25 will not power on after being plugged in for at least 5 minutes, contact Alicat.

Issue: *The buttons do not work, and the screen shows LCK alternating with battery icon.*

Action: The FP-25 buttons were locked out via a serial command. Press and hold all four outer buttons to unlock the interface.

Issue: *I can't read the display easily.*

Action: During the day, you can increase the visibility of the display by increasing the contrast (**MENU > SETUP > ADV SETUP > LCD CNTRST**). If you are working under low-light conditions, push the large Alicat button (located under the display) to turn on the backlight.

Issue: *How often do I need to calibrate my Alicat?*

Action: Alicat recommends annual recalibrations, which reflects current US EPA expectations as well. Check your FP-25's last calibration date by selecting **MENU > ABOUT > DEVICE INFO**. If it is time to recalibrate, request a recalibration at alicat.com/service.

Issue: *Can I use the Alicat when it is freezing outside?*

Action: Yes! Even though we at Alicat live under Tucson, Arizona's hot sun, we have vigorously tested the FP-25 down to -30°C to ensure it remains accurate for our cold-weather friends.

Issue: *I dropped my Alicat. Is it ok? Do I need to recalibrate?*

Action: Your FP-25 has no moving parts and was designed to survive drops from a rooftop air monitoring site. If it turns on and appears to respond normally, then it is probably ok. It may or may not need a recalibration. Compare it against a known-good flow standard. If it checks out, keep using it, but tell us about the drop at your next annual recalibration so we can check it out for you.

Issue: *My Alicat got wet on the outside. Is it ok?*

Action: Your FP-25 has IP67 connections and was designed to keep working in the rain. If it turns on and appears to respond normally, then it is ready for your next flow calibration!

Troubleshooting Your FP-25

Issue: *Water got into my Alicat's flow path. Is it ok? Do I need to recalibrate?*

Action: Prolonged exposure to water can damage the flow sensors over time. That said, your FP-25 uses the same basic technology that we use in our liquid flow meters, so the occasional ingress of liquid will not destroy it. First, let the FP-25 dry out; running some pure anhydrous isopropyl alcohol through it can help it dry faster. You can verify the flow path is dry when the humidity sensor shows readings consistent with your local humidity. If the water was salty and left deposits, you may need a recalibration. Compare it against a known-good flow standard. If it checks out, keep using it, but tell us about the issue at your next annual recalibration so we can check it out for you. If the water was dirty, your FP-25 may require cleaning at Alicat.

Issue: *Can I use the Alicat to check dilution calibrator flow controllers?*

Action: In a pinch, you can use the FP-25 to verify the mass (standardized) flow rates of the mass flow controllers inside a dilution calibrator, but not the volumetric flow rates. (Be sure that the outlet of the FP-25 is open to atmosphere.) This is because the FP-25 is always referencing barometric pressure for its volumetric measurements. For a better solution to verify flow rates for MFCs, ask us about our MWB "Whisper" series, or visit alicat.com/ambient.

Temperature Readings

Issue: *How do I know which temperature reading the Alicat is using?*

Action: The FP-25 indicates which temperature source it is using on the right side of the screen in Standard Mode or the top left in Direct Mode. When your FP-25 is using the external probe for temperature readings, the word **Probe** appears; when the internal temperature sensor is being used, the word **Stream** appears. This temperature source status alternates with the relative humidity reading (RH%).

Issue: *Why does my averaged temperature measurement show St+Pr?*

Action: If you begin an averaged measurement with the external temp probe connected and then disconnect it during the averaging process, the FP-25 will report **St+Pr** to indicate that the temperature measurement includes averaged data from both sources. Start a new measurement to get a reading from just one temperature source.

Issue: *How can I see temperature in different units?*

Action: From Standard Mode, push the button above the temperature reading twice, and then choose **Set button eng units**. Use the **UP/DOWN** keys to move the > cursor to the desired unit, and then press **SET**.

Troubleshooting Your FP-25

Issue: *When should I use the external temperature probe?*

Action: We recommend always using the external temperature probe as your first choice. Because it is isolated, its temperature response is faster than the sensor inside your Alicat's flow stream. Keep the tip of the probe in a bit of shade or inside a radiation shield for best results.

Issue: *The internal temperature sensor doesn't match the external probe.*

Action: The temperature sensor inside the flow body is the same kind as the one at the end of the external probe. However, the internal probe has the larger mass of the aluminum flow body around it, and this takes longer to equilibrate than the tip of the external probe. Your FP-25 always references the external probe temperature to provide flow readings whenever it is connected. If you are not using the external probe, do be sure to allow time for the flow body to equilibrate to ambient temperature.

Issue: *Do I need to sheath the shaft of the probe in direct sunlight?*

Action: Nope! The temperature sensor at the tip of the probe is thermally isolated from the rest of the shaft. The tip will temporarily heat up in response to direct sunlight, but your readings will quickly settle to ambient temperature once you insert the probe into a radiation shield or place its tip in the shade. Do not sheath the metal shaft in an attempt to insulate it; this makes the probe's response slower and can lead to poor performance.

Issue: *Can I immerse the external probe in a temperature bath?*

Action: Yes, we do this at Alicat, too. The internal electronics of the probe are not exposed, so you can immerse it up to an inch shy of its handle.

Pressure Readings

Issue: *How can I see pressure in different units?*

Action: From Standard Mode, push the button above the pressure reading twice, and then choose **Set button eng units**. Use the **UP/DOWN** keys to move the > cursor to the desired unit, and then press **SET**.

Issue: *How do I know which pressure reading the Alicat is displaying?*

Action: Above the pressure reading in Standard Mode, or to its right in Direct Mode, the FP-25 displays BARO when the pressure reading is from the barometer. If you have set your FP-25 to display internal pressure, the pressure unit will end with **A** for absolute pressure (e.g. **mmHgA**) or **G** for gauge pressure (e.g. **mmHgG**).

Troubleshooting Your FP-25

Issue: *When should I use absolute pressure instead of barometric pressure?*

Action: Under most conditions, you will likely want to display barometric pressure readings, which show the ambient atmospheric pressure. During leak checks, you can use the internal pressure (with absolute or gauge reference) to monitor the inside pressure of the air sampler.

Issue: *The internal absolute pressure doesn't match the barometer.*

Action: The absolute pressure reading shows the current pressure inside the FP-25. When there is no flow, these should match each other, as long as one port is open to atmosphere. If they do not, perform a tare by pressing **MENU > TARE**.

Flow Readings

Issue: *How can I see flow in different units?*

Action: From Standard Mode, push the button below the flow reading twice, and then choose **Set button eng units**. Use the **UP/DOWN** keys to move the > cursor to the desired unit, and then press **SET**.

Issue: *How low can I flow?*

Action: Your FP-25 uses laminar flow technology, so you will find it accurate down to at least 0.1 lpm. In practice, we often see great accuracy below this level, too! At these low flow rates, it is important to tare the FP-25 (**MENU > TARE**) before each calibration.

Issue: *The live flow readings won't settle down.*

Action: The FP-25 is very fast, so it can detect subtle variations in flow that may go unnoticed by your other flow calibrators. This sensitivity can help detect problems with sampler pumps or flow controllers. You can record a single flow reading by collecting an averaged measurement (press **START AVG** from the **Instant** screen).

Issue: *My flow readings are negative.*

Action: If your FP-25 is not connected to anything, it may be reading a light breeze that is entering its outlet. Plug one end to see if the flow returns to 0. Under conditions of no flow, a negative flow reading can indicate a poor tare. Ensure that the FP-25 has no flow passing through it, and select **MENU > TARE** to give it a fresh tare.

Issue: *Does the Alicat work if it is laying down? Will it be accurate?*

Action: Yes to both! The FP-25 is internally compensated for any changes in orientation, so you can use it sideways, on its back, or upside-down.

Issue: *Can I put the Alicat on top of a vibrating sampler? Will it be accurate?*

Action: Yes, and yes! The FP-25 is internally compensated for any changes in orientation, including rapid vibrations.

Troubleshooting Your FP-25

Issue: *Volumetric flow readings don't match another flow calibrator I use.*

Action: The FP-25 is the first flow calibrator to account for the content of water vapor in the air (relative humidity). The live humidity sensor keeps up with changing humidity levels all the way to 100% RH. The higher the humidity, the more deviation you may see when comparing FP-25 flow readings to uncompensated flow instruments.

When the air is dry, differences in flow readings are likely the result of pressure drop. Every flow meter has some amount of pressure drop, especially those that use differential pressure as the measurement method. Differing amounts of pressure drop can result in different flow readings when used with samplers that do not actively control their pumps to maintain their target flow rates. This difference is most noticeable when the FP-25 is mounted in Direct Mode, since the barb fittings attached to flow audit adapters act to restrict flow rates.

Issue: *Mass flow readings don't match another flow calibrator I use.*

Action: Check the STP or NTP settings (**MENU > SETUP > BASIC CONFIG > STP/NTP**) to ensure that your standardized temperature and pressure references match those of your other flow calibrator.

Issue: *My flow readings won't change when flow changes.*

Action: If your flow readings are fixed near 0 or 25 lpm and won't change regardless of actual flow, your flow sensor may be damaged. Please contact Alicat to troubleshoot the issue.

Issue: *Can I use the Alicat with other gases?*

Action: No, the FP-25 is designed specifically to work with ambient air at any humidity level, 0-100% RH. If you need a flow calibrator to use with other gases (like CO, CO₂, NO_{x/y} or SO₂), ask us about our MWB "Whisper" series, or visit alicat.com/ambient.

Humidity Readings

Issue: *Can I use the Alicat in 100% humidity? Even when it is hot?*

Action: Yes! The FP-25 is the first flow calibrator to be just as accurate in a Miami summer as it is here in Arizona. The live humidity sensor keeps flow readings accurate from 0% RH to 100% RH, even at 60°C. However, take care that moisture is not condensing inside the flow path, as this will negatively affect its measurement accuracy.

Issue: *Can I use the humidity readings for EPA reporting?*

Action: No. The accuracy of the humidity sensor is 3.5% RH, which falls below the 2% accuracy that the EPA requires.

Troubleshooting Your FP-25

Issue: *The relative humidity reading does not match my humidity standard (or the current weather report).*

Action: The relative humidity sensor is located adjacent to the flow stream in the body of the FP-25. It is most accurate when there is a fresh flow of air passing by it. Connect the FP-25 to an air sampler and check the humidity reading after a couple minutes.

Serial Communications

Issue: *My computer can't find the Alicat when it is connected.*

Action: Check that the FP-25 is powered on. Check the "Ports (COM & LPT)" category in Device Manager for an entry that says "USB Serial Port (COM#)". If you don't see that entry, download and install the USB driver from alicat.com/drivers.

Issue: *I can't communicate to the Alicat when it is connected to my PC.*

Action: Check the "Ports (COM & LPT)" category in Device Manager for an entry that says "USB Serial Port (COM#)". Make sure the COM number matches the one your software is using to connect to the FP-25. Check the FP-25 unit ID (**MENU > SETUP > ADV SETUP > COMM SETUP > SERIAL COMM > UNIT ID**) to make sure you are addressing it properly with your serial commands. Make sure the baud rate your software requires is the one your FP-25 is using (**MENU > SETUP > ADV SETUP > COMM SETUP > SERIAL COMM > BAUD**).

Issue: *Serial communications are very slow or disconnected (FP-25BT).*

Action: If your FP-25BT is already communicating with the Alicat Connect app over Bluetooth, your wired serial connection will not work in most cases. Disconnect your FP-25BT from Alicat Connect and reestablish serial communications through the USB cable.

Bluetooth Communications and Alicat Connect™

Issue: *Which devices work with the FP-25BT's Bluetooth?*

Action: The FP-25BT uses an app called Alicat Connect to communicate over Bluetooth. This app is currently available only for Android mobile devices and is available as a free download from Google Play.

Issue: *My Android device can't find my FP-25BT.*

Action: Do you have the Bluetooth antenna connected to your FP-25BT? Also check that the antenna is active (**MENU > SETUP > ADV SETUP > COMM SETUP**). On your Android device, check the Settings menu to ensure that its Bluetooth antenna is on.

Troubleshooting Your FP-25

Issue: *My Android device found my FP-25BT but won't connect to it.*

Action: If you have multiple FP-25BT's in range, make sure the serial number you're connecting to in Alicat Connect matches your intended FP-25BT. Next, look at the signal strength (RSSI) shown in the Bluetooth Scanner of Alicat Connect. An RSSI of -90 or lower indicates a very weak signal. Reposition your mobile device and/or the FP-25BT's antenna to get a stronger signal. Avoid metal shelves and cabinets.

Issue: *Nothing happens when I start an averaged measurement.*

Action: First, be sure you are looking at the darker Averaged Data table, and not the lighter gray Instant Data table. If you can see a countdown at the bottom of the table next to **Meas Time Remain**, then the FP-25BT is taking a new average. If you do not see the countdown, reconnect your mobile device to your FP-25BT by tapping the back arrow [←].

Issue: *How can I access the data I monitored in Alicat Connect?*

Action: The Alicat Connect app does not store any data itself, but the last 50 averaged measurements are stored in your FP-25BT's Stored Averages log (**MENU > STORED AVGS**). You can access this data by connecting your FP-25BT to your computer. (See "*Taking Averaged Measurements Serially*" on page 43.)

Issue: *I have an FP-25 without Bluetooth. How can I add Bluetooth?*

Action: Get in touch with us (888-290-6060 or info@alicat.com) to find out what your options are for upgrading your FP-25 to an FP-25BT.

Still stumped?

Issue: *None of the above helped. Arrgh!*

Action: We're here to help! It's going to be ok. Give us a call (888-290-6060) during our normal business hours (8am-5pm Arizona time) to get help from a friendly and capable applications engineer. Or, go to alicat.com and start a live chat. Is it after hours? Send an email to info@alicat.com, and we'll get in touch with you as soon as we can.

Maintenance and Recalibration

Cleaning

Your FP-25 flow calibrator requires no periodic cleaning. It has no moving parts and is built tough to survive drops from a rooftop monitoring station. If necessary, the outside of the device can be cleaned with a soft dry cloth.

Recalibration

The recommended period for recalibration is once every year. A label located on the back of the device lists the most recent calibration date. This date is also stored inside your FP-25 and is visible by selecting **MENU > ABOUT > DEVICE INFO**.

When it is time for your FP-25's annual recalibration, contact us by phone or live chat to set it up. After hours, send an email to service@alicat.com, or fill out the form at alicat.com/service. We'll ask for your device's serial number and your contact information and send you an email with instructions for returning the FP-25 to us. We typically complete a recalibration within 10 business days.

Replacement Parts

Please contact Alicat to reorder any of the following FP-25 accessories:

Part Number	Description
FP-PROBE	External temperature probe for FP-25
FP-DMA1	¼" NPT Direct Mode PM inlet adapter (1.25" OD)
FP-DMA2	¼" NPT Direct Mode downtube adapter (1.25" ID)
FP-BARB	¼" NPT barb fitting for ¼" hoses
FP-TUBE	5-foot length of ¼" ID x 7/16" OD silicone tubing
FP-BTA	Positionable Bluetooth antenna (for FP-25BT only)
PVPS5USB	USB cable, micro-B to type A, with wall adapter
SCASE	Waterproof hard case with custom foam insert

For repair, recalibration or recycling of this product contact:

Alicat Scientific, Inc.

service@alicat.com • alicat.com

7641 N Business Park Drive Tucson, AZ 85743 USA

1-520-290-6060

Specifications

Technical Data for FP-25 Flow Calibrator

The Alicat FP-25 is an easy-to-use, NIST-traceable device for audit and calibration of volumetric flow, ambient temperature, and barometric pressure.

Specifications

Performance	FP-25 Flow Calibrator
Instrument Flow Range	0.125 to 25.000 lpm / slpm
Flow Accuracy and Repeatability	± 1.0% of Reading (at calibration conditions after tare)
Operating Range / Turndown Ratio	0.5% to 100% Full Scale / 200:1 Turndown
Pressure Drop with Fittings	0.10 psi @ 16.7 lpm 0.16 psi @ 25.0 lpm
Barometric Pressure Accuracy	±1 mmHg across 475-825 mmHg
Temperature Probe Accuracy	±0.2° Celsius
Relative Humidity Accuracy	±3.5% RH
Typical Response Time	10 ms
Warm-up Time	< 1 Second
Battery Life	12 hours
Recharge Time	3.5 hours with 2A USB supply and device turned off

Operating Conditions	FP-25 Flow Calibrator
Mass Reference Conditions (STP)	25°C & 14.696 psia (adjustable)
Operating / Storage Temperature	-30 to +60° Celsius
Charging Temperature	0 to +45° Celsius
Humidity Range (Non-Condensing)	0 to 100% RH with live humidity sensing
Maximum Internal Pressure (Static)	45 psig
Maximum Allowable Instantaneous Differential Pressure Across Device (Inlet to Outlet)	15 psid
Proof Pressure	175 psig
Mounting Attitude Sensitivity	None
Wetted Materials	6061 Aluminum, 302 Stainless Steel, Heat Cured Silicone Rubber, Glass Reinforced Polyphenylene Sulfide, Heat Cured Epoxy, Gold, Silicon, Glass.

Communications / Power	FP-25 Flow Calibrator
Monochrome LCD	Simultaneously displays Volumetric Flow, Standard Flow, Barometric Pressure and Ambient Temperature.
Digital Output Signal	RS-232 Serial via Micro-USB-B connection
Electrical Connection	Micro-USB-B
Supply Voltage	+5 Vdc (Micro-USB-B)

Unit and Included Accessories	FP-25 Flow Calibrator
Weight	1.4 lb. (6.7 lb. with case and accessories)
Dimensions	7.6" x 1.4" x 2.5" (12.5" X 14.5" x 5.4" in hard case)
Protective case	Waterproof Hard Case
Fittings	Direct Mode adapters for 1.25" OD sampler downtubes, 1/4" NPT barb fitting
Tubing	1/4" ID X 7/16" OD Silicone Tubing (5 ft)
Warranty	Lifetime

Mechanical Drawings

FP-25 Flow Calibrator

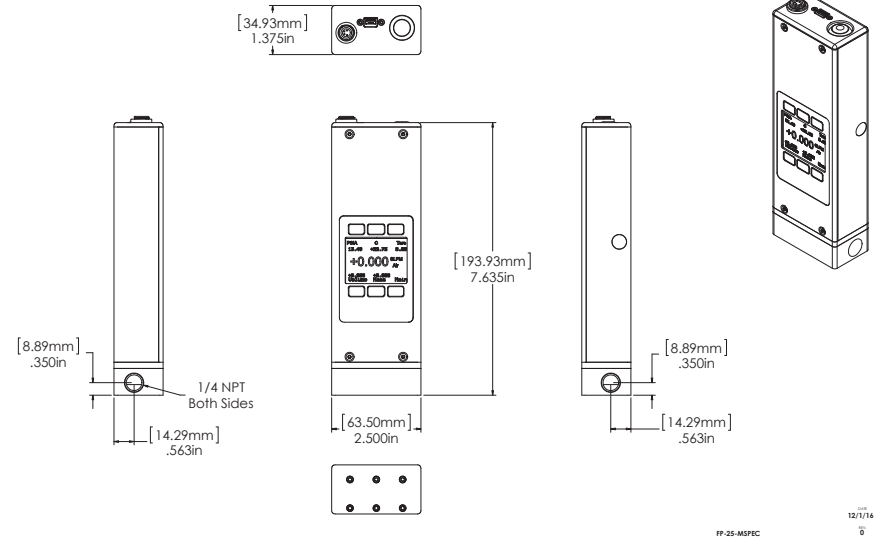

Fittings

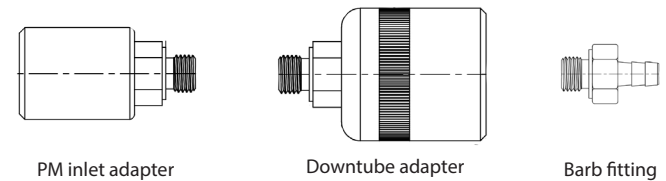

Notice: Alicat Scientific reserves the right to make any changes and improvements to the products described in this manual at any time and without notice. This manual is copyrighted. This document may not, in whole or in part, be copied, reproduced, translated, or converted to any electronic medium or machine readable form, for commercial purposes, without prior written consent from the copyright holder.

Note: Although we provide assistance on Alicat Scientific products both personally and through our literature, it is the complete responsibility of the user to determine the suitability of any product to their application.

Limited Lifetime Warranty

Alicat Scientific, Inc. warrants to the original purchaser (hereinafter referred to as "Buyer") that instruments manufactured by Alicat Scientific (hereinafter referred to as "Product") shall be free from defects in materials and workmanship for the life of the Products.

Under this warranty, the Products will be repaired or replaced at manufacturer's option, without charge for parts or labor when the Product is carried or shipped prepaid to the factory together with proof of purchase.

The foregoing shall constitute the exclusive and sole remedy in lieu of other remedies of the Buyer for any breach by Alicat Scientific of this warranty to the maximum extent permitted by law.

This warranty does not apply to any Product which has not been installed or used in accordance with the Product operation and installation specifications provided to Buyer verbally or in writing by Alicat Scientific for the proper and normal use of the Product.

Buyer agrees hereunder that Alicat reserves the right to void any warranty, written or implied, if upon Alicat's examination of Product shall disclose to Alicat's satisfaction that the Product failure was due solely, or in part, to accident, misuse, neglect, abuse, alteration, improper installation, unauthorized repair or improper testing by Buyer or agent of Buyer.

Alicat Scientific shall not be liable under any circumstances for indirect, special, consequential, or incidental damages in connection with, or arising out of, the sale, performance, or use of the Products covered by this warranty.

Alicat Scientific does not recommend, warrant or assume responsibility for the use of the Products in life support applications or systems.

Alicat's warranties as herein above set forth shall not be enlarged, diminished or affected by, and no obligation or liability shall arise or grow out of Alicat's rendering of technical advice in connection with Buyer's order of the Products furnished hereunder.

If Product becomes obsolete, Alicat Scientific, at its own discretion, reserves the right to repair the Product with available replacement parts or upgrade the Product to a current, commercially available version of the original Product. Should upgrading the Product be deemed necessary by Alicat, Buyer hereby agrees to pay an upgrade fee equal to seventy percent of the retail value of the replacement Product. Alicat Scientific hereunder makes no claim that replacement Products will look, function or operate in the same or similar manner as the original product.

When a Product is returned to Alicat Scientific for recalibration this service is considered normal preventative maintenance. Recalibration of Product shall not be treated as a warranty service unless recalibration of Product is required as the result of repairs to Product pursuant to this Warranty. Failure of Buyer to send Product to Alicat Scientific for recalibration on a yearly basis after a period of 36 months from date of manufacture will remove any and all obligations regarding repair or replacement of Product as outlined by this Warranty to Buyer from Alicat Scientific.

This Warranty is in lieu of all other relevant warranties, expressed or implied, including the implied warranty of merchantability and the implied warranty of fitness for a particular purpose, and any warranty against infringement of any patent.

Continued use or possession of Products after expiration of the applicable warranty period stated above shall be conclusive evidence that the warranty is fulfilled to the full satisfaction of Buyer.

Alicat makes no warranty as to experimental, non-standard or developmental Products.

Accessories purchased from Alicat are not covered by this warranty.

Conformity / Supplemental Information:

The product complies with the requirements of the Low Voltage Directive 2006/95/EC and the EMC Directive 2004/108/EC and carries the CE Marking accordingly. Contact the manufacturer for more information.

FP-25 Reference Menu Map

- * Pressing **MAIN** returns you to the Instant Data screen of either Standard Mode or Basic Mode, whichever was last used.

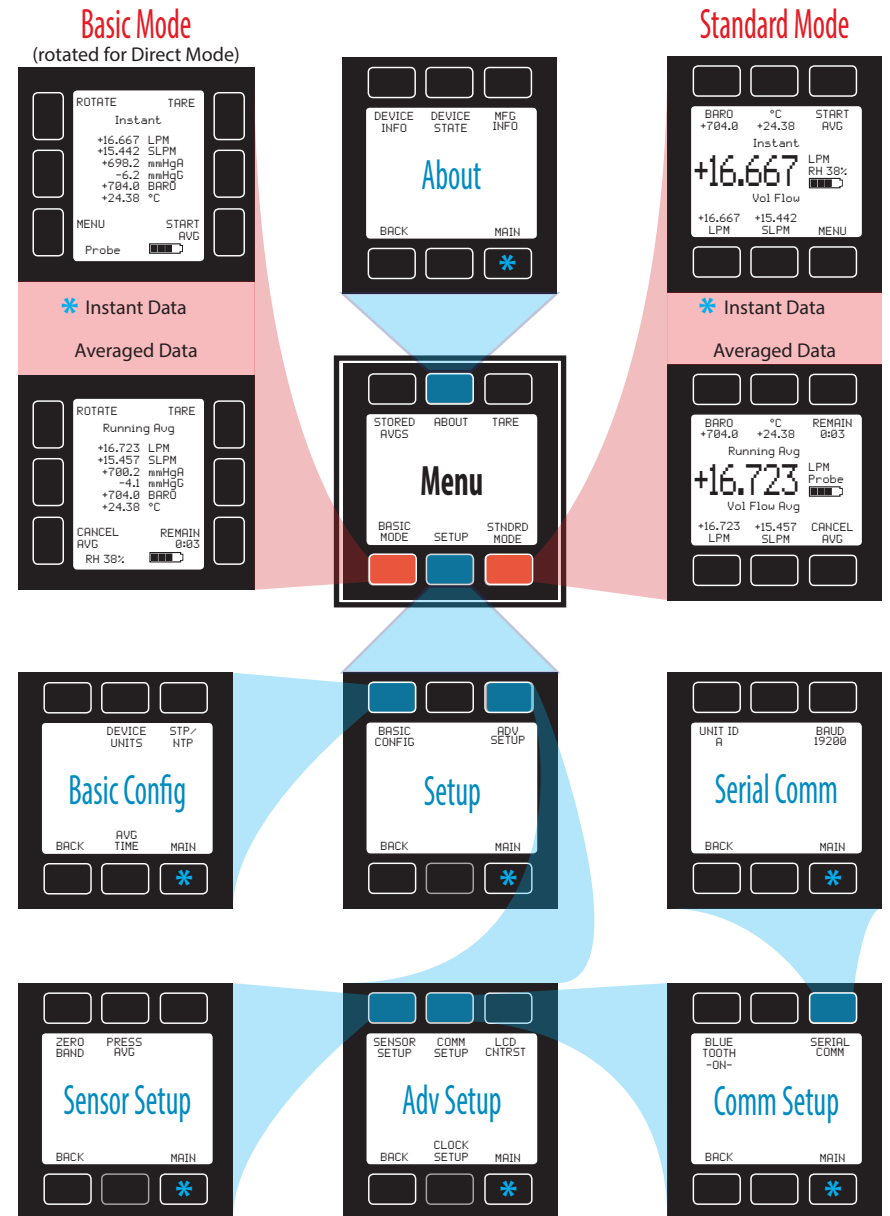

Direct Mode | Samplers with 1.25" Downtubes or Adapters

- 1 Connect external temp probe.

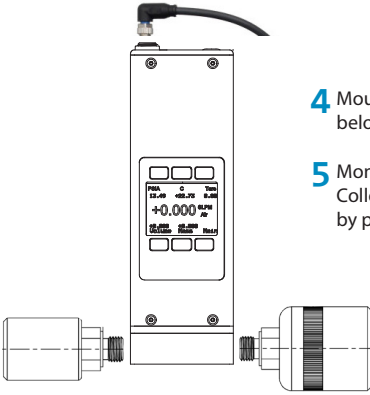

- 2 Connect PM inlet adapter (inlet) and downtube adapter (outlet).
- 3 Turn on. Tare the device: **MENU > TARE**. Enter Direct Mode: **MENU > BASIC MODE > ROTATE**.

- 4 Mount to sampler downtube below the PM10 inlet.
- 5 Monitor live flow readings. Collect an averaged measurement by pressing **START AVG**.



Standard Mode | Hose Barb Connection to Samplers

- 1 Connect external temp probe.

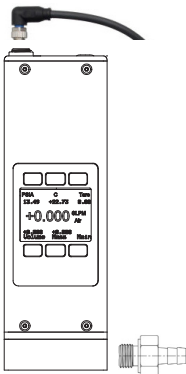

- 2 Connect barb fitting.
- 3 Turn on. Tare the device: **MENU > TARE**.

- 4 Connect silicone tubing to barbs of FP-25 and flow audit adapter or sampler inlet.
- 5 Monitor live flow readings. Press any parameter twice to change units. Collect an averaged measurement by pressing **START AVG**.

