



## RHE 42

# Field Mount All-digital High Performance Multifunction Mass Flow Transmitter

Filling and batching / Robot mounted flow measurement / Any high accuracy/reliability plant flow or density measurement / Oil and Gas / Mixing and blending of chemicals / PU and Paint / Compact flow measurement for OEM's and skid manufacturers / High pressure, low flow chemical injection measurements – sensors up to 1400 bar (20000 psi) available





## Features

- Fully digital design – no risk of potential measurement drifts due to analogue components' temperature behavior
- Latest signal processing and filtering techniques allowing 0.05% accuracy on flow measurement over the entire range
- Measurement update rates of 4kHz by patented Fast Response Software Version
- Real time clock incl. battery on board plus 1 Gb memory for data collection and later off-line analysis
- Display with Color backlit display with 3 through-glass buttons for local configuration and operation through an intuitive user menu
- Multifunction performance provides simultaneous mass flow, volumetric flow, density and temperature measurements
- First in class connectivity with USB, Modbus RTU, Modbus TCP/IPv4, HART, Profibus PA, Foundation Fieldbus H1
- Classical output as 4-20mA, pulse, frequency, status – also available as intrinsically safe outputs
- 8 totalizers - 2 non-resettable, 6 for mass/volume (positive, negative, net flow)
- License-free RHEComSoftware package for configuration and servicing
- RHEComPro+ Software Suite for extended diagnostics incl. simulator for training
- Connects to any Rheonik Coriolis sensor

## General Specification Overview

<b>Enclosure Material</b>	Coated aluminum	
<b>Enclosure Rating</b>	IP65/NEMA 4, optional up to IP66/67 and NEMA 4X/6 Ambient -40°C to +65°C (caution with display - temp. restr.)	
<b>Ambient Temperature</b>	-20 to +60°C / -4 to +140°F, optional -40°C to +65°C / -40°F to 149°F Integral version depends upon fluid temperature, refer to next page	
<b>Dimensions</b>	Enclosure approx. 144 x 108 x 139 mm / 5.67 x 4.25 x 5.47 in Weight approx. 2.3 kg / 5.1 lbs	
<b>User Interface and Configuration</b>	<u>Local Display Version</u> High contrast backlit LCD color display and 3 x through-glass operator buttons. Configure locally or with RHECom software Reduced display visibility below -10°C / 14°F	<u>Blind Transmitter Version</u> No local controls. Configure through RHECom software package
<b>Connection to Sensor</b>	Integral/Compact to sensor or remote mount with 3m/10m cable	
<b>Cable Entries</b>	2 x ½" NPT for power and I/O	
<b>Totalizers</b>	6 x resettable forward, reverse and net totalizers for mass and volume 2 x non-resettable totalizers for mass and volume	
<b>Analog Outputs</b>	Up to 2 x 4-20mA outputs, active or passive. Intrinsically safe versions available	
<b>Pulse/Freq/Status Outputs</b>	Up to 2 configurable pulse/frequency/status outputs (IEC60946). Max. 10kHz. Intrinsically safe versions available (open collector)	
<b>Digital Inputs</b>	Up to 2 configurable control inputs (IEC60946). Intrinsically safe versions available	
<b>Digital Data Communications</b>	HART, Modbus RTU, Ethernet (Modbus TCP/IPv4), Profibus PA, Foundation Fieldbus H1 (FISCO)	
<b>Power Supply</b>	12-24 VDC +/- 10%, 2W typical, 4W maximum	
<b>Hazardous Area Approvals</b>	ATEX/IECEX: Zone 1, 2 CSA: Class 1, Div. 2	

## Hazardous Area Installation Overview



*Sensor and transmitter must have matching approvals*

## Temperature Specification

Integral/compact RHE42 transmitters are available on RHM06S to RHM20S sensors with sealless construction types and N1/NA/E2 process temperature ratings. For other sensor types, the RHE42 transmitter must be remotely mounted.

### Operating temperature range for close coupled RHE42

N1/NA ratings -20/-50°C to +120°C

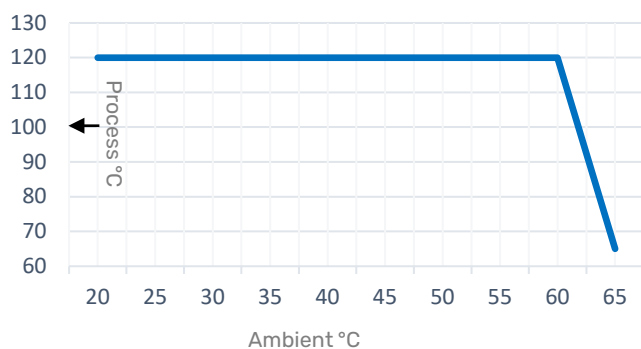

### Operating temperature range for set-off RHE42

E2 rating -50°C to +210°C

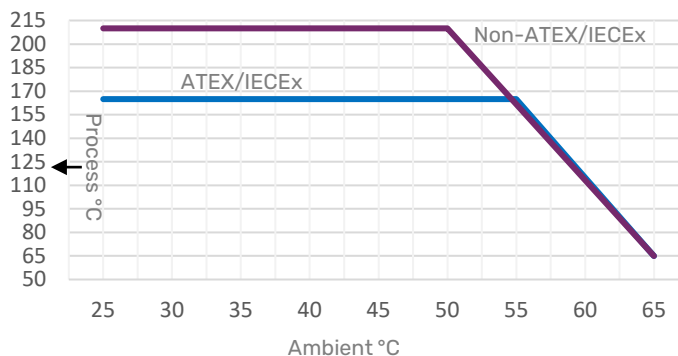

## RHE42 Output Configurations

The RHE42 is available with a variety of standard I/O configurations to provide the ultimate in flexibility and value for all users. Rheonik also offers a custom configuration option to provide I/O combinations not listed below.

Part Number Code	DO pulse/freq /status	DI	AO 4-20mA	Modbus RS485	Modbus TCP/IPv4 (wired)	HART	FFH1 FISCO	Profibus PA
B1	2	1		Y				
EB	2	1		Y	Y			
EA	2	1	2 (a/p)	Y	Y	Y		
S1	2	1	1 (a/p)	Y				
1H	2	1	1 (a/p)	Y		Y		
S2	2	2	2 (a/p)	Y		Y		
i1	2 (is)		1 (p/is)	Y		Y		
i2	1 (is)	1 (is)	2 (p/is)	Y		Y		
FF				Y			Y	
F2	1 (is)		1 (p/is)	Y			Y	
PA				Y				Y
P2	1 (is)		1 (p/is)	Y				Y
XX	Customer Specified							

*is – intrinsically safe, a – active, p – passive*  
*uncertainty of analog outputs is +/- 0.1% of reading, +/- 10µA*

## Software Function Packages and Features

### Standard Operation Package (Part Number Code S0)

The RHE42 Standard Operation Package provides the following measurement and function features:

#### Direct Mass Flow Measurement

Mass flow is calculated using the Coriolis principle to provide a high accuracy Mass Flow measurement of the fluid flowing through an Omega Tube Coriolis Meter.

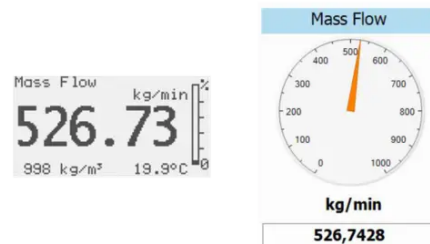

#### Temperature Measurement

Each Omega Tube Coriolis Sensor provides a temperature measurement from built in sensors.

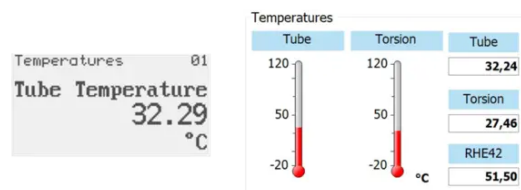

#### Fixed and Calculated Density Function

The Fixed Density function allows to enter a fixed density value for volumetric flow calculations.

The Calculated Density function allows density to be generated based upon process temperature. A base/reference density at a known temperature is entered for the fluid being measured along with a coefficient describing the change in density per temperature unit. The firmware in the transmitter calculates flowing density based upon this information to use for volumetric flow calculations.

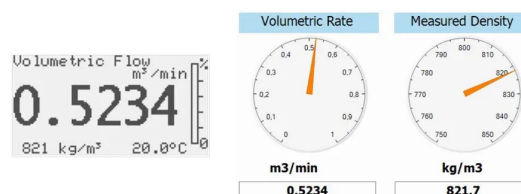
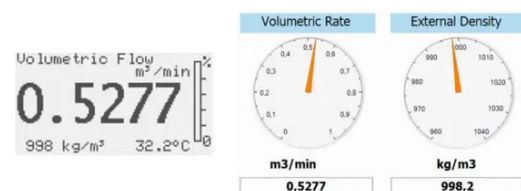

#### Calculated Actual Volume Measurement for Liquids and Gas

Volume measurement is calculated by dividing direct mass flow measurement by the Fixed Density.

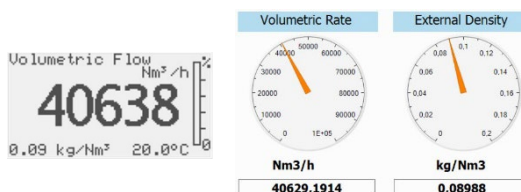

#### Standardized/Normalized Volume Measurement for Gas

This function calculates the volume of gas passing through the meter at standard conditions. The density of the gas at standard conditions is entered into the transmitter and the volume is calculated using this in conjunction with the flowing mass.

**Standard Package (Part Number Code S0) continue**

**Password Protection**

All setup and calibration parameters within the meter are protected with passwords to prevent unintentional or unauthorized change once installed.



**Batch Controller**

The transmitter is equipped with an onboard batch controller that, in conjunction with external pumps and/or valves allows the precise delivery of a preset mass or volume of process fluid on demand. Operated from the instrument front panel, remotely via operator switches or through digital communication from a connected supervisory control system, the controller is configured to utilize either a one stage or a two stage delivery strategy in ensuring the right amount of fluid is batched through the meter. The electronics self-learns, adjusting shut off times as more and more batches are delivered to further refine the amount of delivery, saving material costs and improving quality.

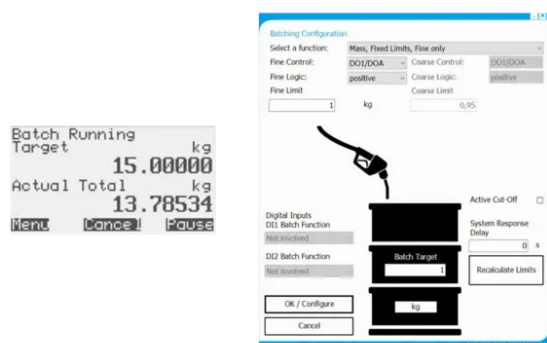

**Assurance View® Diagnostics**

Inbuilt self-monitoring functions are available that can be used to determine the reliability of the flow meter readings at all times. Diagnostics are quickly accessed through dedicated menu displays, RHECom software and the MODBUS interface.



**Density Operation Package (Part Number Code D0)**

The RHE42 Density Operation Package includes all features from the Standard programming package plus the following measurement and function features:

**Direct Density and Volume Measurement**

The flowing density of the fluid in an Omega Tube Coriolis Sensor is determined from the measured resonant frequency of the sensor and used to calculate instantaneous volumetric flowrate.

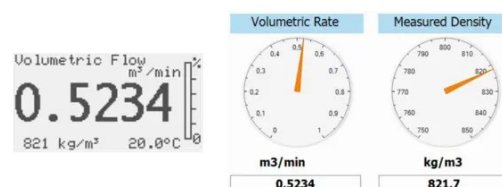

**Density Package (Part Number Code DO) continue**

**Brix/Baume Units**

The unit can be configured to read out in °Brix or Baume. °Brix or Baume are used extensively in the sugar and beverage industries.

°Brix  
°Bé

**Partially Filled Pipe Management – Lite Version**

Often referred to as multiphase flow, the flow regime in a partially filled pipe can cause large measurement errors and even create a measurement fault condition in a Coriolis Flow Meter. When PFPM is activated, density measurement is continuously compared to preset limits to determine if the sensor is seeing a liquid/gas mixture running through it. When multiphase flow is detected, it can be signaled, e.g. by a DO, to alert users and allow action to be taken to minimize error. The full version of PFPM is available with the Assurance Diagnostics Package – see the next section for details.

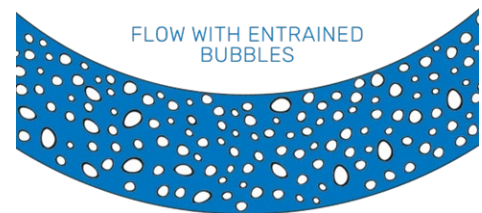

**Assurance Factor Package with Assurance Diagnostics Suite (Part Number Code AF)**

The RHE42 Assurance Factor Package includes all features from the Density Operation Package plus the following advanced diagnostic functions:

**Assurance Factor®**

Assurance Factor® is a numeric value generated by an internal algorithm that indicates the overall health of the flow meter and measurement. Assurance Factor® value can be used to trigger changes in screen color when the optional display is fitted to the RHE42 (White – Amber – Blue – Red), providing highly visible wide area condition indication.

ASSURANCE  
Factor® ○ ● ● ●



**WHITE**

Normal  
Operation

No faults present. All parameters within expected limits. Meter fully operational



**AMBER**

Operation  
Not Optimal

Sensor subject to noise / changing conditions in pipe. Measurement quality may be compromised



**BLUE**

Operation  
at Limit

Sensor experiencing disturbance. Measurement quality compromised

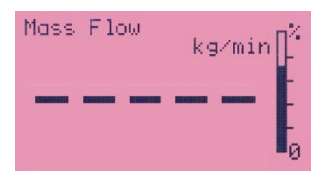

**RED**

Measurement  
Failure

Sensor experiencing extreme disturbance / meter in fault. Measurement offline

**Assurance Factor Package (Part Number Code AF) continue**

**Zero Point Setting History/Statistics**

All RHE42 transmitters with the AF advanced diagnostics package log the last 10 zero points for inspection and troubleshooting. Zero point setting is very dependent upon installation conditions and is therefore specific to each sensor in the field. Comparing zero point history can help identify installation and operation issues that could effect accuracy and performance of the flow meter.

```

**** Zero Point 3 ****
Date: 2022-03-18 11:27
Run Time: 646
Zero Point: -0.03
Tube Temp.: 20.00
Torsion Temp.: 20.00
Var. Phase: 0.573977
Var. Period: 1.37525
    
```

History of Zero Points stored in the RHE

Time	Run Time	i Zero Point [Ticks=8ns]	Zero Point [kg/min]	Tube Temp. °C	Torsion Temp. °C	RHM Freq. (Hz)	Drive (m)
2022-03-18 11:27:04	640	-0.04186	-0.01582283	20.02	19.98	89.54103	851.9
2022-03-18 11:27:11	646	-0.02913	-0.01101117	20.00	20.00	89.54103	858.7
2022-03-18 11:27:18	654	-0.02209	-0.008349222	19.93	20.07	89.54104	846.3
2022-03-18 11:27:25	661	-0.01942	-0.007339118	20.04	19.96	89.54103	840.4

**Partially Filled Pipe Management – Full Version (PFPM)**

In this full version of the PFPM function, two different monitoring methods are used, either separately or in conjunction with each other, to detect when mixed phase fluid is flowing through the Coriolis flow sensor. When the PFPM function is in operation, density measurement and/or sensor pickup voltage levels are closely monitored to determine if the sensor is seeing a liquid/gas mixture running through it. Upon detection, actions can be taken to minimize measurement inaccuracy and process disruption. The program feature also allows “bridging” an interrupted measurement (e.g. heavy gas bubbles) for up to 60 s with the last valid measurement values.

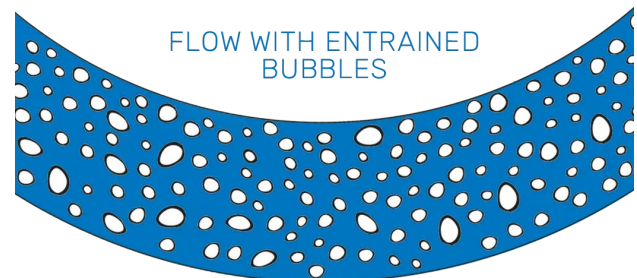

**PID Controller**

A PID controller is implemented in the transmitter to provide direct control to a valve or pump via a 4-20mA output for flow control purposes. The PID controller function features fully tunable PID parameters for either mass or volumetric flow rate. Set-point can be established via the front keypad/display or remotely via digital communication.

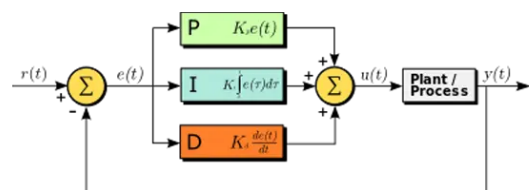



**Assurance Factor Package (Part Number Code AF) continue**

**Data Recording**

The fluid transfer package contains fully featured onboard data recording with a capacity of 1 Gbit to record over 500,000 time stamped records. Records include all measured variables and totalizers along with diagnostic data. Recording interval can be set from 1 to 600 seconds and recording started and stopped through the display user menu or via Modbus. Data is downloaded by request through Modbus. The RHECom software package provides a simple interface to configure the data recorder and download recorded data.

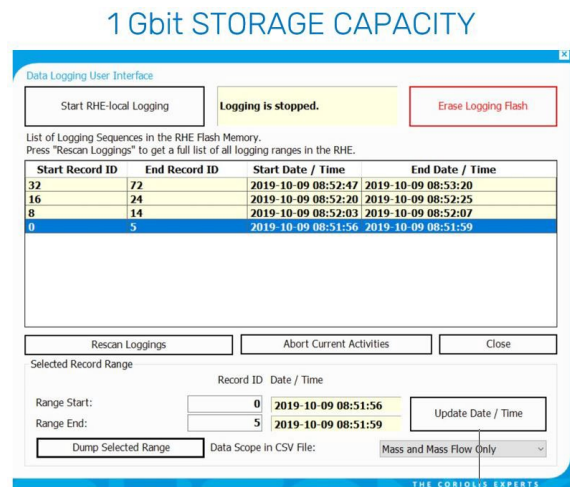

**Oil and Gas Function Package (Part Number Code OG)**

The Oil and Gas Function Package includes all features from the Assurance Factor Package plus the following advanced measurement applications:

**API Standard Density/Volume**

When configured for this application, the transmitter will calculate density at standard conditions to API MPMS Chapter 11. All three product groups – crude oil, refined products and lubricants can be metered using this built-in application. Precise calculation requires temperature and pressure inputs. Both inputs can be supplied through manual user menu entries or through Modbus updates to the transmitter or the internal tube temperature of the sensor. Volume flow and totalization at standard conditions are generated using the calculated standard density value.

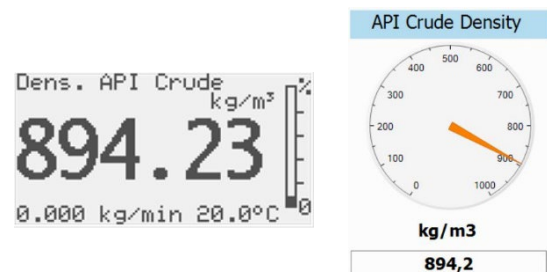

**Net Oil Calculation**

Crude Oil is often mixture of oil and water and it is desirable to know the actual oil content. With this function, it is possible to calculate the net oil amount in a flowing stream using a live density measurement. The standard density (at standard temperature and pressure) of both the crude oil and the water/other portions of the stream must be provided as inputs for the calculation. These can be entered manually through the transmitter's user menu or digitally via Modbus.

**NET OIL**



**Oil and Gas Function Package (Part Number Code OG) continue**

**Percent Concentration Calculation**

Percent concentration of a fluid in a mixture of two fluids (i.e. alcohol in water) or solids in liquid can be determined using the percent concentration function. With this function, the density of both components in the stream must be provided as inputs for the calculation. These values are entered manually through the transmitter’s user menu or digitally via Modbus and should be updated as temperature conditions change to obtain the best performance.

Data View/Monitoring			
Address	Name	Value	Unit
0x480C	VolPercentMainSubstance	53,96152	%

**Custody Transfer Package (Part Number Code CT)**

The Custody Transfer Package includes everything from the Oil and Gas Function Package plus the following features:

**Precision Flow Analysis (PFA)**

For fast fill applications down to 0.5s duration measurements, transmitter update time can be increased to 4ms. This allows a 250Hz totalizer update rate (50Hz is standard) to maintain very fast tracking of actual volume/mass delivered, and e.g. through the internal batch control function, results in a maximum signal delay of 10-20ms to a connected control valve once the batch set-point is reached. Depending upon the speed of operation of the fill valve, repeatable accuracies of better 1% are achievable for filling operations of 500ms duration and less.



**Hardware Lock Switch**

For applications such as custody transfer where sealing is required. This switch, when engaged, prevents change of any setting within the transmitter through both the user panel interface and through a digital communications port. To accommodate some special customer needs the Lock Switch configured to leave a totalizer reset and/or a zero calibration possible.

Once the Lock Switch is set, a tamperproof seal can be applied to the transmitter case to indicate if the transmitter has not been opened since sealing.



### Fast Response Package (Part Number Code FR)

For applications requiring an extremely fast response to flow e.g. extremely fast filling applications of less than 500 ms, the transmitter offers a unique Fast Response Package.

#### Fast Response Package

For extremely fast fill applications down to 5-10 ms measurements, a patented fast response filter technology is employed within the transmitter to speed up measurement update time to better 1 ms. With an additional internal fast sampling mode this allows a 4kHz measurement update rate to maintain very fast tracking of actual volume/mass delivered, and e.g. through the internal batch control function, results in a maximum signal delay of 1ms to a connected control valve once the batch set-point is reached. Depending upon the speed of operation of the fill valve, repeatable accuracies of 0.5% are achievable for filling operations of 500ms and less.

The fast fill function has a variety of tuning parameters and their setting will largely depend on the operating conditions (temperature, pressure, density, target delivery, etc.) of the filling system. For users of the Fast Response Package, Rheonik will provide assistance with initial configuration and tuning of the transmitter. The tuning parameters can be further optimized on site using the Precision Flow Analysis Tool.

The unique Precision Flow Analysis (PFA) tool allows data sampling of up to 4 kHz (requires a Modbus TCP/IPv4 connection) and subsequent analysis. By transferring the data into a calculation spreadsheet the fluid dynamics can be graphically reviewed – a powerful help to optimize a sophisticated fluid handling system e.g. such as a satellite engine.

The Fast Response Package includes all functions and features of the Fluid Transfer Package.



**Mass Flow Measurement  
of 10 ms Injections**

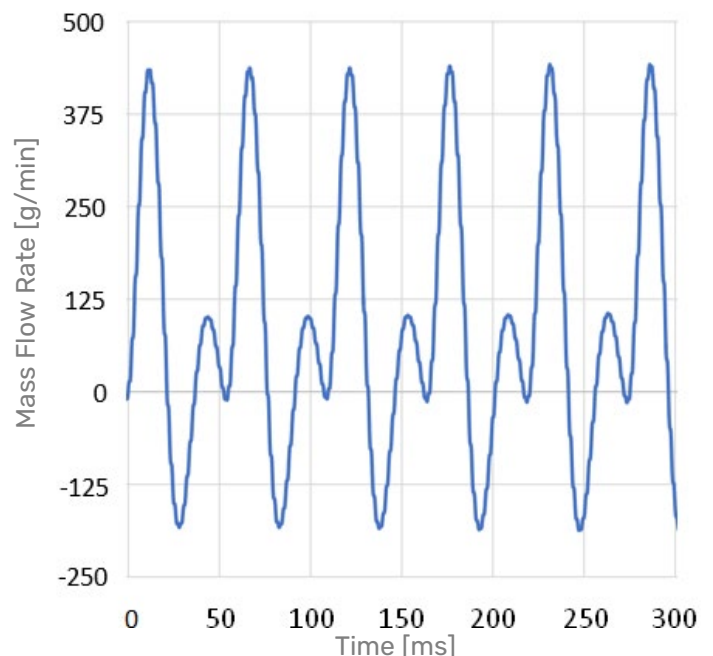

## Program Package Function Summary

Feature	Program Package Code					
	SO	DO	AF	OG	CT	FR
Live Mass Flow Measurement	X	X	X	X	X	X
Live Temperature Measurement	X	X	X	X	X	X
Inferred Density by Reference Density and Temp.	X	X	X	X	X	X
Fixed or Norm Density Value (e.g. kg/Nm <sup>3</sup> )	X	X	X	X	X	X
Volumetric Flow from Inferred/ Fixed/Norm Density	X	X	X	X	X	X
Standardized Gas Volume Calculation	X	X	X	X	X	X
Resettable Mass / Volume Totalizers	X	X	X	X	X	X
Non-Resettable Mass / Volume Totalizers	X	X	X	X	X	X
Single and Two Stage Batch Control	X	X	X	X	X	X
Self Learning Batch Control	X	X	X	X	X	X
Assurance View® Diagnostics	X	X	X	X	X	X
Setup/Configuration Password Protection	X	X	X	X	X	X
Live Density Measurement		X	X	X	X	X
Volume using Mass and Measured Density		X	X	X	X	X
Brix / Baume Units		X	X	X	X	X
Assurance Factor® Calculation and Diagnostics			X	X	X	X
Zero Point Monitoring and History			X	X	X	X
Onboard Data Recording			X	X	X	X
PID Controller for Analog Output (e.g. Pump, Valve)			X	X	X	X
Partly Filled Pipe Management			X	X	X	X
Onboard Data Recording			X	X	X	X
API Standard Density/Volume				X	X	X
Net Oil Calculation				X	X	X
Concentration/Percent Substance Calculation				X	X	X
Precision Flow Analysis / up to 250 Hz Update Rate					X	X
Hardware Lock Switch					X	X
Super Fast Response / Filling Firmware Set						X
Precision Flow Analysis / 4 kHz Update Rate						X

## RHECom Software

The RHE42 transmitter is a fully featured device with many sophisticated functions and configuration is necessary for proper performance of these functions. RHECom software is available in three versions – Free, Pro and Pro+.

RHEComFree is available for download at no extra cost or on USB flash drive. RHEComFree allows full setup of transmitter parameters and includes a useful datalogging function for monitoring performance of the meter.

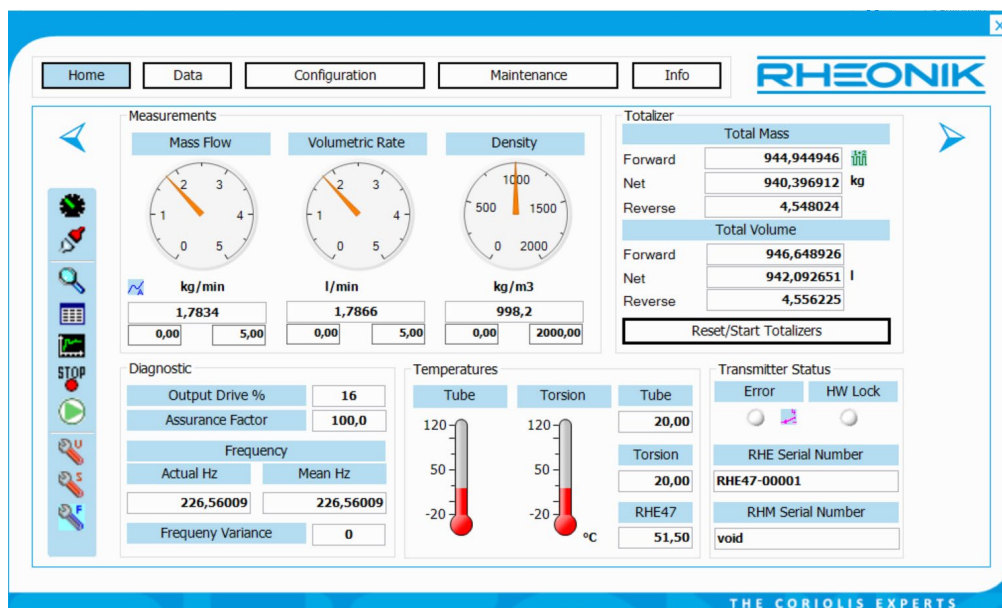

For a small one-time license fee, RHEComPro and RHEComPro+ offer additional insight and setup convenience menus. RHEComPro includes data logging, trending and broad diagnostic capabilities.

RHEComPro+ takes flow meter management one step further with a revolutionary fully functioning simulator application. With the simulator, you can trial run your application from the convenience of your office, adjusting transmitter settings, setting alarms and filters, and creating transmitter configuration files for upload into the actual unit. The simulator is also ideal for training - it exactly mimics the front panel of the instrument display and buttons when clicked and includes controls for adjusting flow, density and temperature readings just like the unit was in line!

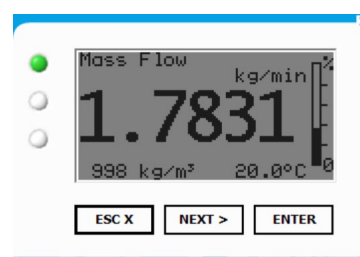
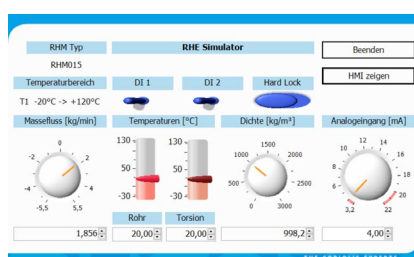

RHECom software is designed to ensure simple and expedient setup of Rheonik transmitter features and functions – a real time saver and a valuable tool.

## Mechanical Construction

### RHE42 Dimensions Integral/Compact Mount (C\*)

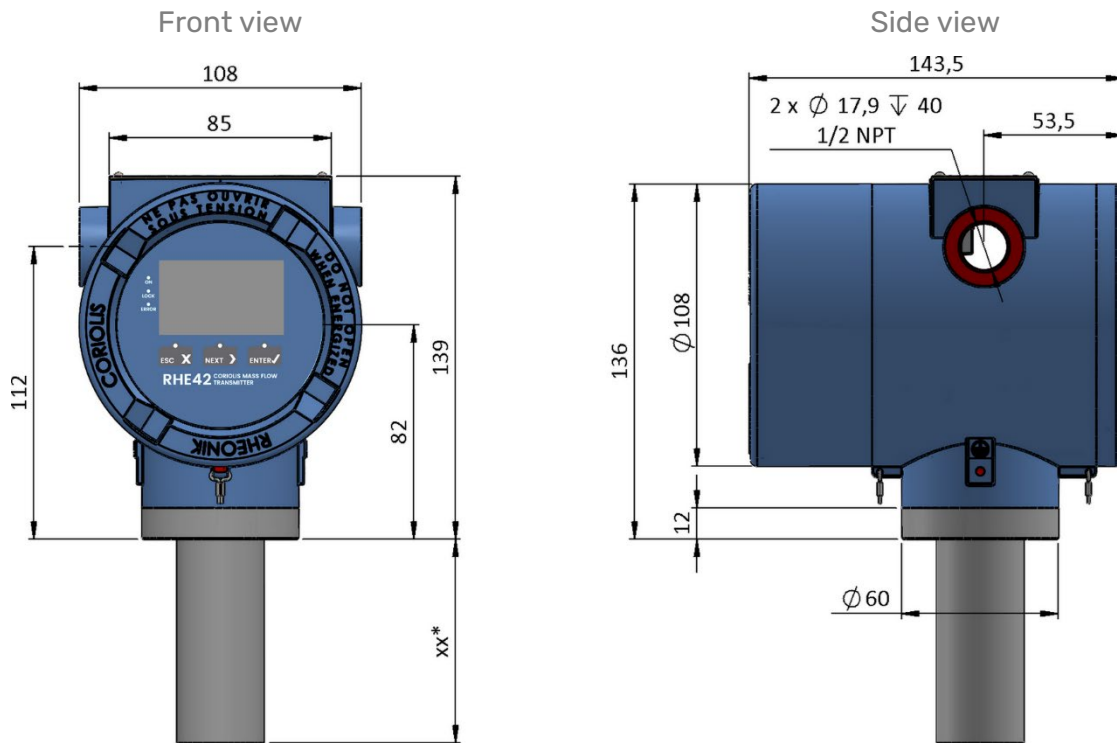

### RHE42 Dimensions Integral/Compact Mount (R\*)

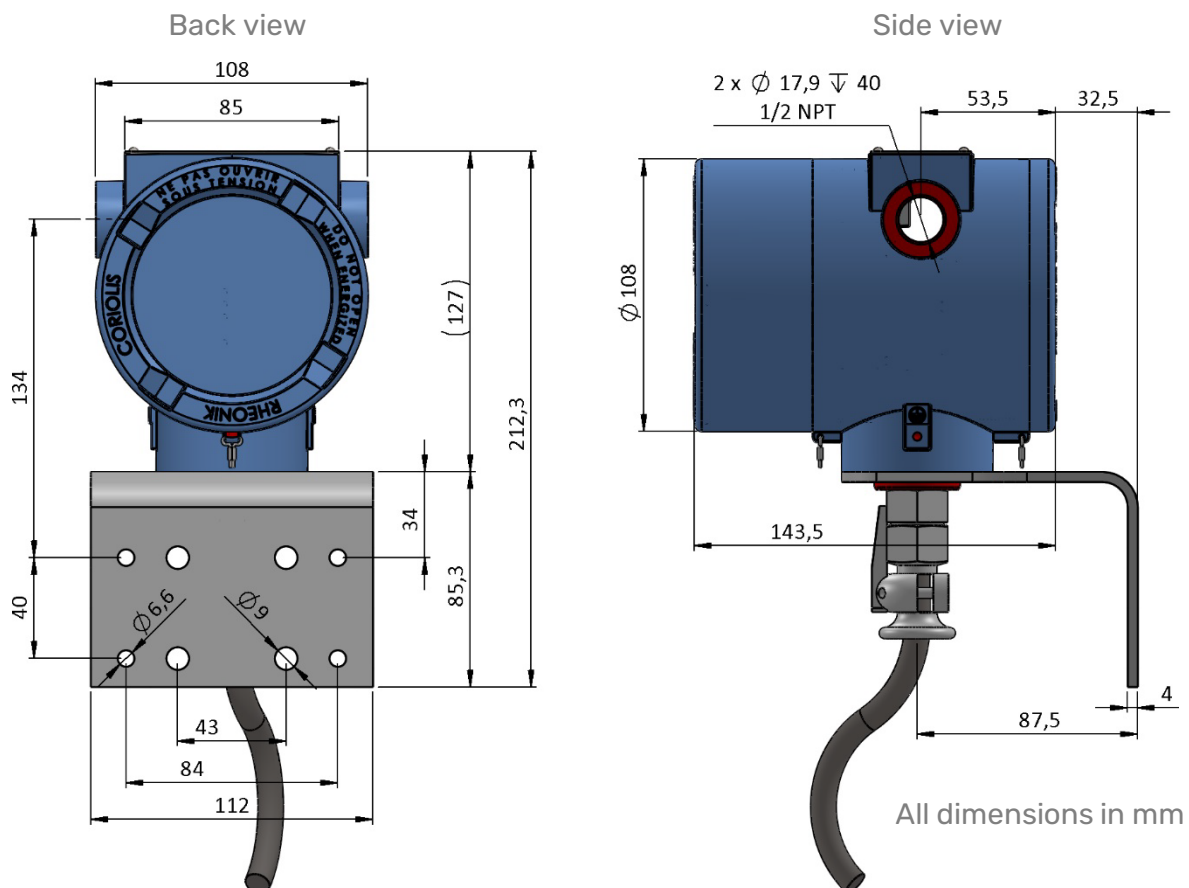

## Transmitter Range

Any Rheonik Mass Flow Transmitter model can be combined with any Rheonik Mass Flow Sensor to provide an overall mass flow measurement system to suit any requirement. Rheonik Coriolis Transmitters are available in versions specifically designed for process, industrial and OEM applications. Economical blind front versions of some transmitters are available where displays and keypads are not required. The wide range of sensors and transmitters provide tremendous options for system designers and end users alike.

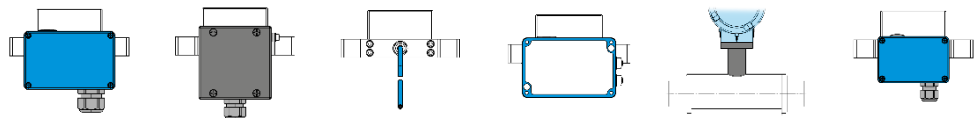

Product Code	JM	SM	TM	J5	C2	PM
 RHE 21	✓	✓	✓	-	-	✓
 RHE 26	✓	✓	✓	-	-	✓
 RHE 27	✓	✓	✓	-	-	✓
 RHE 28	✓	✓	✓	-	-	✓
 RHE 42	✓	✓	✓	-	✓	✓
 RHE 45	-	-	-	✓	-	-

# RHE 42 Part Number Code

## Construction Type

- RB Remote Mount Alu Enclosure IP65 Exd(e), ambient -20 to +60°C, without display and 3m integral cable
- RC Remote Mount Alu Enclosure IP65 Exd(e), ambient -20 to +60°C, without display and 10m integral cable
- RD Remote Mount Alu Enclosure IP65 Exd(e), ambient -20 to +60°C, with color display and 3m integral cable
- RE Remote Mount Alu Enclosure IP65 Exd(e), ambient -20 to +60°C, with color display and 10m integral cable
- C1 Compact Mount Alu Enclosure at Sensor IP65 Exd(e) without display
- CD Compact Mount Alu Enclosure at Sensor IP65 Exd(e), with color display

## Supply Voltage

- D1 12 to 24 VDC (+/- 10%)

## Software Function Package

- SO Standard OP system - mass flow, normalized density / volume, Assurance View® Diagnostics
- DO Enhanced OP system - SO plus measured density / volume
- AF Enhanced OP System plus Assurance Factor®, ZP History, Data Recording, PID Controller, PFFM
- OG Enhanced OP System plus AF, API Standard Density/Volume, Net Oil Calculation, Concentration
- CT Enhanced OP System plus OG, Precision Flow Analysis, Hardware Lock Switch
- FR Enhanced OP System plus CT, Super Fast Response Firmware with 4 kHz Update Rate

## I/O Configuration

- B1 Base Configuration - 2\*DO, 2\*DI, RS485 (Modbus)
- EB Base TCP Configuration - 2\*DO, 2\*DI, Modbus TCP / IPv4, RS485 (Modbus)
- EA TCP All - 2\*4/20mA (a/p), 2\*DO, 2\*DI, Modbus TCP / IPv4, HART +RS 485 (Modbus)
- S1 Standard One - 1\*4/20mA (a/p), 2\*DO (Pulse/Freq/Status), 1\*DI, RS485 (Modbus)
- 1H Standard One plus HART
- S2 Standard Two - 2\*4/20mA (a/p), 2\*DO (Pulse/Freq/Status), 2\*DI, HART + RS485 (Modbus)

## Intrinsically safe output options

- i1 Standard One is - 1\*4/20mA (is, p), 2\*DO (Pulse/Freq/Status - is), HART + RS485 (Modbus - non is)
- i2 Standard Two is - 2\*4/20mA (is, p), 1\*DO (Pulse/Freq/Status - is), 1\*DI (is), HART + RS485 (Modbus - non is)
- FF Foundation Fieldbus FFH1 (FISCO), RS485 (Modbus - non is)
- F2 Foundation Fieldbus FFH1 (FISCO), 1\*4/20mA (is, p), 1\*DO (is), RS485 (Modbus - non is)
- PA Profibus PA, RS485 (Modbus - non is)
- P2 Profibus PA, 1\*4/20mA (is, p), 1\*DO (is), RS485 (Modbus - non is)

## Hazardous Area Certifications (See page 18 for more information)

- NN Without - RHM and RHE in ordinary locations
- AS ATEX/IECEx Ex II (1)G [Ex ia Ga] IIC (RHE in ordinary locations)
- A2 ATEX/IECEx Ex II 3(1)G Ex db ec [ia Ga] IIC T6/T4 Gc - (I/O Options F\* and P\* only with T4)
- A1 ATEX/IECEx Ex II 2(1)G Ex db eb [ia Ga] IIC T6/T4 Gb - (I/O Options F\* and P\* only with T4)
- AD ATEX/IECEx Ex II 2(1)D Ex tb [ia Da] IIIC T85°C Db - RHE in zone 21 or 22
- CS cCSAus approval, RHE installation in ordinary locations
- C2 cCSAus approval, RHE installation in Class I, Div. 2
- C1 cCSAus approval, RHE installation in Class I, Div. 1 and 2
- CD cCSAus approval, RHE installation in Class I, Div. 1 and 2

## Performance Certification

- NN Without
- R7 Custody transfer certification OIML-CS R117 - requires Hardware Lock Switch
- 9R Custody transfer certification OIML-CS R139 - requires Hardware Lock Switch
- AB ABS approval for Marine applications

## Options for RHE42

- NNN None / All standard
- N67 Enhanced enclosure dual rating IP66/67 NEMA 4X/6 2), ATEX/IECEx only IP66
- NNH Hardware Lock Switch Function (included in CT, FR Software Function Package)





## Options and Accessories

Part Number	Description
<b>ORHE-SI</b>	Pre-setting of pulse, analog outputs according to setting instructions.
<b>ARHE42-HM</b>	Quality HART Modem (to connect via USB to PC)
<b>ARHE42-H</b>	Bracket for pipe mounting (max.D=50mm / 2") in stainless steel
<b>ARHE42-H-316</b>	Bracket for pipe mounting (max.D=50mm / 2") in SS316
<b>ARHE42-SF</b>	Sunshade for RHE21/42

## General Options

Part Number	Description
<b>ARHE-SO</b>	USB flash drive with PC software RHEComFree, operation manual, calibration certificate(s), csv configuration file(s). One USB drive per order is sufficient. For RHE16/2X/4X
<b>ARHE-PW</b>	DIN Rail Power Supply Module 85 to 250 V to 24 VDC / 15 W (Non Ex) for RHE16/26/27/42
<b>ARHE-MO</b>	Modbus RS485 terminals to PC USB Converter for RHE16/2X/4X
<b>ARHE-PR</b>	PC Software RHEComPRO license key (upgrade for two years are included)
<b>ARHE-PP</b>	PC Software RHEComPRO+ license key (upgrade for two years are included)
<b>ORHE-TP</b>	Plate with TAG number in Stainless Steel (other labelling standard)
<b>ORHE-TP-C</b>	Complete labelling (type information, TAG, Ex label) in Stainless Steel
<b>MAN-</b>	Additional RHE manual printout

## Hazardous Area Certifications

Code	Construction Type	Zone / Division	Approval		Labeling
<b>A1</b>		Zone 1	ATEX		II 2(1)G Ex db eb [ia Ga] IIC T6 Gb
<b>A1</b>	I/O: F*, P*	Zone 1	ATEX		II 2(1)G Ex db eb [ia Ga] IIC T4 Gb
<b>A2</b>		Zone 2	ATEX		II 2(1)G Ex dc eb [ia Ga] IIC T6 Gc
<b>A2</b>	I/O: F*, P*	Zone 2	ATEX		II 2(1)G Ex dc eb [ia Ga] IIC T4 Gc
<b>AS</b>		safe area	ATEX		II (1)G [Ex ia Ga] IIC
<b>A1</b>		Zone 1	IECEX		Ex db eb [ia Ga] IIC T6 Gb
<b>A1</b>	I/O: F*, P*	Zone 1	IECEX		Ex db eb [ia Ga] IIC T4 Gb
<b>A2</b>		Zone 2	IECEX		Ex db ec [ia Ga] IIC T6 Gc
<b>A2</b>	I/O: F*, P*	Zone 2	IECEX		Ex db ec [ia Ga] IIC T4 Gc
<b>AS</b>		safe area	IECEX		[Ex ia Ga] IIC
<b>C1</b>		Div 1, Zone 1	Zone USA/Kanada	Class I, Zone 1, AEx db [ia Ga] IIC T6 Gb; Ex db [ia Ga] IIC T6 Gb	
<b>C2</b>		Div 2, Zone 2	Zone USA/Kanada	Class I, Zone 2, AEx nA [ia Ga] IIC T6 Gc; Ex nA [ia Ga] IIC T6 Gc	
<b>CS</b>		safe area	Zone USA/Kanada	[Ex ia]; [Ex ia Ga] IIC	



## About Rheonik

Rheonik has but one single purpose: to design and manufacture the very best Coriolis meters available.

Our research and engineering resources are dedicated to finding new and better ways to provide cost effective accurate mass flow solutions that provide value to our customers. Our manufacturing group care for each and every meter we produce from raw materials all the way to shipping, and our service and support group are available to help you specify, integrate, start-up and maintain every Rheonik meter you have in service. Whether you own just one meter or have hundreds, you will never be just another customer to us. You are our valued business partner.

Need a specific configuration for your plant? Don't compromise with a "standard" product from elsewhere that will add extra cost to your installation. If we can't configure it from our extensive and versatile product range, our exclusive **AnyPipeFit Commitment** can have your flow sensor customized with any size/type of process connection and face to face dimension you need.

No matter what control system you use as the backbone in your enterprise, with our **AnyInterface Commitment**, you can be sure that connection and communication will not be a problem. Alongside a wide variety of discrete analog and digital signal connections, we can also provide just about any network/bus interface available (for example: HART, ProfibusDP, ProfiNet, EtherCAT, PowerLink, EtherNet/IP, CAN, ....) with our RHE 40 Series family of transmitters. Rheonik RHE 40 Series transmitters can connect to your system – no headache and no conversion needed.

Rheonik Messtechnik GmbH  
Rudolf-Diesel-Straße 5  
D-85235 Odelzhausen  
Germany

Tel + 49 (0)8134 9341-0  
info@rheonik.com

